

ALIAS 

DESIGN SECURITY DOORS

Guardare
al futuro
anticipando
i tempi

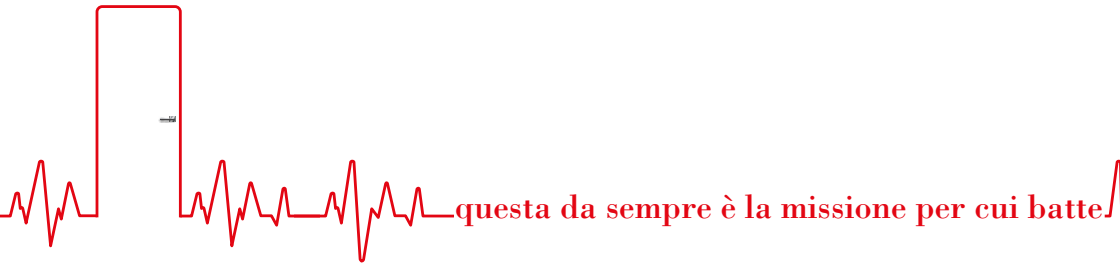

questa da sempre è la missione per cui batte il cuore Alias.



PERFORMANCE, TECNOLOGIA, RESISTENZA: UNA PORTA DI SICUREZZA ALIAS È IL CONNUBIO TRA QUALITÀ E DESIGN. UN PRODOTTO PENSATO PER GARANTIRE PRESTAZIONI ECCELLENTI, DALL'EFFICACIA ANTIEFFRAZIONE ALL'ABBATTIMENTO ACUSTICO, TESTATO PER 50.000 APERTURE, L'EQUIVALENTE DI 30 ANNI DI SICUREZZA ASSOLUTA.

DESIGN SECURITY DOORS COLLECTION

Performance, technology, resistance: Alias Security Door is a perfect match between quality and design. A product projected to ensure excellent performance from anti-burglary efficiency to the acoustic abatement, tested for 50.000 openings, the equivalent of 30 years of absolute security.

Performance, technologie, résistance: la porte de sécurité Alias constitue le lien entre qualité et design. Un produit projeté pour garantir d'excellentes performances allant de l'efficacité antieffraction à l'affaiblissement acoustique, testées sur 50.000 ouvertures, correspondant à 30 ans de sécurité absolue.

PORTE CHE SI CHIUDONO
PER APRIRSI VERSO
MONDI E LUOGHI INTIMI,
VERSO SPAZI CHE VUOI
VIVERE E RITROVARE.
LE PORTE ALIAS
PROTEGGONO LA TUA
IDEA DI CASA, IL TUO
SPAZIO E, ESATTAMENTE
COME VUOI TU,
COSTITUISCONO IL TUO
STILE. PERCHÉ ALIAS
È SICUREZZA INSIDE,
DESIGN OUTSIDE.

Doors that close to open towards
worlds and intimate places, towards
spaces you want to live in and to find
again. Alias doors protect your
home idea, your place and represent
your style, as you want, because
Alias is security inside, design
outside.

Les portes qui se referment pour
s'ouvrir sur un monde nouveau, sur
des lieux intimes, sur des espaces
à retrouver et à vivre. Les portes
Alias expriment votre conception
d'habitat et d'espace exactement
selon vos désirs, elles caractérisent
votre style étant donné qu'Alias
est sécurité à l'intérieur et design à
l'extérieur.

Guardare al futuro anticipando i tempi.



La forte identità dell'azienda, riconosciuta non solo a livello nazionale come eccellenza "Made in Italy" nel settore porte di sicurezza, è sicuramente da attribuire alla sua grande capacità di visione. E per "guardare al futuro, anticipando i tempi" occorre avere coraggio: il coraggio d'investire costantemente nell'attività di "Ricerca&Sviluppo" e nella diverse professionalità e capacità delle PERSONE, per andare sempre oltre la soglia del know-how acquisito. In Alias la parola "innovazione" non è un concetto aprioristico, ma il risultato di un percorso quotidiano sempre in divenire, che si fonde indissolubilmente con la tradizione artigiana. E così, il sapere degli artigiani rifinisce un prodotto nato dalle più moderne tecnologie e mutuato dalla ricerca formale ed estetica, oltre che funzionale e prestazionale. L'accurata ricerca di materiali e soluzioni tecnologiche esaltano il gusto per il dettaglio impeccabile, in una tensione verso un ideale di bellezza che coinvolge tutti i comparti dell'azienda.

"Perché dietro ad ogni porta c'è una storia, unica ed irripetibile: una famiglia, bambini che crescono emozioni senza tempo e piccoli dettagli quotidiani. Sono queste le storie di cui ci sentiamo responsabili e che ispirano il nostro lavoro, sempre oltre la soglia della qualità, sempre pronti all'innovazione"

DARIO VACCARI
Presidente ALIAS SRL

The strong identity of the company, recognized not only at a national level as "Made in Italy" excellence in the security doors sector, is certainly due to its great ability of vision. And to "look to the future, anticipating the times" it is necessary to have courage: the courage to invest constantly in the activity of "Research & Development" and in the different professional skills and abilities of people, to always go beyond the threshold of acquired know-how. In Alias the word "innovation" is not an "a priori" concept, but the result of a daily path that is always in progress, which is inextricably blended with the artisan tradition. And so, the knowledge of the artisans finishes a product born from the most modern technologies and borrowed from formal and aesthetic research, as well as functional and performance. The careful research of materials and technological solutions enhance the taste for impeccable detail, striving towards an ideal of beauty that involves all the sectors of the company.

Because behind every door there is a story, unique and unrepeatable: a family, children who grow, timeless emotions and small daily details. These are the stories we feel responsible for and which inspire our work, always beyond the threshold of quality, always ready for innovation

La forte Identité de l'entreprise, reconnue non seulement au niveau national comme excellence du "Made in Italy" dans le secteur portes blindées, est due essentiellement à sa grande capacité de vision. Et pour "Regarder vers l'avenir anticipant les temps", il faut du courage: le courage d'investir constamment en "Recherche et développement" et dans les différentes expertises et compétences des GENS, pour dépasser le rang du know-how obtenu. Dans Alias le mot "innovation" ce n'est pas un concept a priori, mais le Résultat d'un parcours quotidien toujours en devenir, qui fusionne indissolublement avec la tradition artisanale. Alors, les connaissances des artisans affinent un produit qui est né des plus modernes technologies et assuré de la recherche formel et esthétique, ainsi que fonctionnel et de performance. La recherche minutieuse des matériaux et des solutions technologiques glorifient le goût pour l'impeccable détail, dans une tension vers un idéal de beauté qui implique tous les branches de l'entreprise.

"Derrière chaque porte il y a une histoire, unique et non reproductible: une famille, des enfants qui grandissent, émotions au delà du temps et petits détails quotidiens. Ce sont celles-ci les histoires dont on se sent responsables et qui inspirent notre travail, toujours au delà des limites de qualité, toujours prêts à innover.

INDICE

PANNELLI DI RIVESTIMENTO

PANELING
PANNEAUX DE REVETEMENTS

“CONTEMPORARY”

| | |
|---------------------------|-------|
| * METROPOLITAN Collection | P. 12 |
| * CARTOON Collection | P. 25 |
| * LISTEN Collection | P. 30 |
| * PAIS Collection | P. 38 |
| * GIPSY Collection | P. 49 |
| * MARBLE Collection | P. 51 |
| CARGO Collection | P. 55 |
| QUADRANTE | P. 58 |
| MOTION | P. 62 |
| PLANAR | P. 65 |
| LINEA | P. 66 |
| IN OUT Collection | P. 68 |
| SQUARE | P. 71 |
| MOUSE | P. 72 |
| ONDA | P. 73 |
| CACTUS | P. 74 |
| NINE | P. 76 |
| VELA | P. 79 |
| MAP | P. 80 |
| TEN | P. 82 |
| OVAL | P. 85 |

* **NOVITÀ**

“TRADITION”

| | |
|-------------------------------------|--------|
| * RADIANT Collection | P. 88 |
| DIAMANTE Collection | P. 100 |
| SKIPPER Collection | P. 104 |
| SKIPPER - DIAMANTE GLASS Collection | P. 106 |
| FAST Collection | P. 110 |
| NAUTILUS Collection | P. 114 |
| RENO Collection | P. 116 |
| ETERN - ALL Collection | P. 120 |
| PRIMA CLASSE Collection | P. 126 |
| URBAN Collection | P. 130 |
| NATUR - ALL Collection | P. 132 |
| INTARSIO Collection | P. 134 |
| BASIC LINE Collection | P. 136 |
| BASIC Collection | P. 138 |

“FLAT collection”

P. 154

SHOWROOM

P. 166

SISTEMI DI STRUTTURA

Structures System / Structures

| | |
|-----------------------------------|--------|
| STANDARD QUALITATIVI | P. 170 |
| MANIGLIERIA | P. 172 |
| * PORTE BLINDATE A TAGLIO TERMICO | P. 174 |
| * THERMAL SILVER | P. 176 |
| * THERMAL STEEL | P. 178 |
| * ISOLA SILVER | P. 180 |
| * ISOLA STEEL | P. 182 |
| STEEL | P. 184 |
| STEEL PLUS | P. 186 |
| VEGA PLUS | P. 188 |
| STEEL C FB6 | P. 190 |
| DUO | P. 192 |
| SILVER | P. 194 |
| GOLD | P. 196 |
| PLATINUM | P. 198 |
| TITANIUM | P. 200 |
| DOUBLE | P. 202 |
| ZTL | P. 204 |
| MAGMA/30 | P. 206 |
| MAGMA/60 | P. 207 |
| MAGMA/90 | P. 208 |

SOLUZIONI SPECIALI

Special Solutions / Solutions Spéciales

| | |
|----------------------------|--------|
| ZTL | P. 212 |
| DOPPIO BATTENTE | P. 214 |
| PORTALI | P. 218 |
| FINESTRATURE | P. 220 |
| GRATA PER PORTA FINESTRATA | P. 222 |
| SOPRALUCE E FIANCHILUCE | P. 224 |

OPTIONALS

| | |
|---------------------------------|--------|
| SERRATURE MOTORIZZATE | P. 228 |
| * SISTEMI ELETTRONICI COMBINATI | P. 232 |
| FINITURE TELAI | P. 238 |
| CONTROTELAI | P. 240 |

CERTIFICAZIONI

Certificates / Certifications

P. 250

PRESTAZIONI

Features / Performances

P. 254

LEGENDA

Legend / Légende

P. 259



PANNELLI DI RIVESTIMENTO

PANELING
PANNEAUX DE REVETEMENTS

“CONTEMPORARY”

UNA SFILATA DI COLLEZIONI DAL DESIGN SUGGESTIVO, CONTRADDISTINTA DA ACCOSTAMENTI DI MATERIALI INNOVATIVI E RICERCATE LAVORAZIONI. NELLA LINEA CONTEMPORARY TROVERAI LA SOLUZIONE PER DELIMITARE IL TUO SPAZIO CON LO STILE CHE RISPETTA LA TUA PERSONALITÀ.

A show of collections with an evocative design, distinguished by combinations of innovative materials and refined workmanship. In the Contemporary line you will find the solution to define your space with the style that respects your personality to all style requests.

Une parade de collections de design suggestif, caractérisée par rapprochements de matériaux innovants et l'ouvrages soignées. Dans la ligne contemporary tu pourras trouver la solution pour délimiter l'espace avec un style qui respecte ta personnalité.

METROPOLITAN* Collection



È LA NUOVA LINEA DI PANNELLI PENSATA PER GLI INGRESSI CHE RICOPRONO IL RUOLO DI PROTAGONISTI DELLO SPAZIO ABITATIVO. GRAZIE ALLE NUOVE LINEE E ALLE (OPZIONALI) FINITURE DAL FORTE CARATTERE DECORATIVO, DI GUSTO CONTEMPORANEO, CREANO SOLUZIONI DI GRANDE IMPATTO.

METROPOLITAN COLLECTION IS THE NEW LINE OF PANELS DESIGNED FOR ENTRANCES THAT COVER THE ROLE OF PROTAGONISTS OF THE LIVING SPACE. THANKS TO NEW LINES AND FINISHES (OPTIONAL) WITH A STRONG DECORATIVE CHARACTER AND CONTEMPORARY TASTE, THEY CREATE SOLUTIONS WITH A GREAT IMPACT.

EST UNE NOUVELLE LIGNE DE PANNEAUX PENSÉE POUR LES ACCÈS QUI JOUENT RÔLES ESSENTIELS DE L'ESPACE DE VIE. GRÂCE AUX NOUVELLES LIGNES ET AUX FINITIONS FORTEMENT DÉCORATIVES, AUX GÔTS CONTEMPORAINS, LES PANNEAUX CRÉENT SOLUTIONS DE FORT IMPACT.

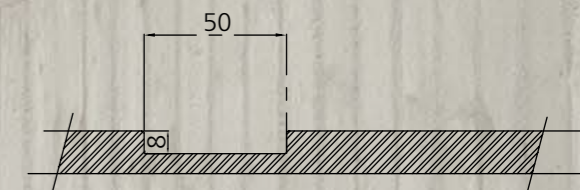

In questa immagine, il modello "CITY 2" della collezione Metropolitan in versione "nuda", priva di inserti, è laccato RAL 1013. La maniglia H4 a rosetta quadrata è in cromo satinato.

In this image, the "CITY 2" model of the Metropolitan collection in bare version, without inserts, is RAL 1013 lacquered. The H4 square rosette handle is in satin chrome.

Dans cette image, le modèle "CITY 2" de la collection Metropolitan en version "nue", sans inserts, est laquée RAL 1013. La béquille H4 avec rosace carrée est en chromé satiné.





**Modello "CITY 1" laccato
RAL 1019 con inserto
in acciaio inox e
maniglia H4 a rosetta
quadrata in cromo
satinato.**

Model "CITY 1" RAL 1019 with
stainless steel insert.
Thick and H4 handle with square
metal cover in satin chrome colour.

Model "CITY 1" laqué RAL 1019
avec insert inox et béquille H4 avec
rosace carrée en chromé satiné.



I DIVERSI MODELLI DI QUESTA COLLEZIONE POSSONO, SU RICHIESTA, ESSERE DOTATI DI UNA SERIE DI INSERTI INEDITI IN ACCIAIO O MDF, CHE NE MOLTIPLICANO ESPONENZIALMENTE LE INTERPRETAZIONI STILISTICHE.

In questa immagine, il modello "CITY 3" in rovere grigio si arricchisce di un inserto in acciaio inox. La maniglia H4 a rosetta quadrata è in cromo satinato.

THE DIFFERENT MODELS OF THIS COLLECTION CAN, ON REQUEST, BE EQUIPPED WITH A SERIES OF NEW INSERTS IN STEEL OR MDF THAT MULTIPLY THEIR STYLISTIC INTERPRETATIONS.

In this image the "CITY 3" model in gray oak is enriched with a stainless steel insert. The H4 square metal cover handle is in satin chrome colour.

LES DIFFERENTS MODELS DE CETTE COLLECTIONS, SUR DEMANDE, PEUVENT ACCUEILLIR PLUSIEURS INSERTS INEDITES EN ACIER OU MDF, QUI EN MULTIPLIENT EXPONENTIELLEMENT LES INTERPRETATIONS STYLISTIQUES.

Dans cette image, le model "CITY 3" en chene gris ornée d'un insert acier inox. La béquille H4 à rosace carrée est en chromé satiné.

**Modello "CITY 3"
in rovere chiaro abbinato
all'inserto in acciaio inox.
La maniglia FENIX a rosetta
quadrata è in cromo satinato.**

"CITY 3" model in light oak combined
with the stainless steel insert.
The FENIX handle with square metal
cover is in chrome satin colour.

Model "CITY 3" en chene clair avec
insert inox. La béquille FENIX avec
rosace carrée en chromé satiné.





Il modello “INTRECCIO VERTICALE” laccato RAL 1019 è impreziosito dall’inserto in acciaio brunito. La maniglia H4 a rosetta quadrata finitura grigio grafite è abbinata al telaio finitura brunitech.

The RAL 1019 lacquered “VERTICAL INTRECCIO” model is embellished by the burnished steel insert. The H4 handle with squared metal cover in gray graphite colour is combined with the brunitech finish frame.

Le model “INTRECCIO VERTICALE” laqué RAL 1019 est orné de l’insert en acier poli. La béquille H4 avec rosace carrée gris graphite est combinée au cadre de couleur brunitech.

L’immagine a destra fa spazio, come un sipario, al modello “INTRECCIO ORIZZONTALE”. Questo pannello della collezione Metropolitan è impreziosito da fresature di due diverse misure (da 50 e 70 mm).

In rovere pietra è abbinato al telaio finitura brunitech. La maniglia FENIX a rosetta quadrata è in cromo satinato.

The image on the right makes space like a curtain to the “HORIZONTAL INTRECCIO” model. This panel of the Metropolitan collection is embellished with milled in two different sizes (from 50 to 70 mm). In stone oak finishing is combined with the brunitech finish frame. The FENIX square metal cover handle is in satin chrome.

L’image à droite nous montre, comme un sipario, le model “INTRECCIO ORIZZONTALE”. Ce panneau de la collection Metropolitan est orné de moulures de deux différentes mesures (de 50 à 70mm) En chene pierre est combiné le cadre de couleur brunitech. La béquille FENIX avec rosace carrée est en chromé satiné.



Particolare della fresatura del modello INTRECCIO VERTICALE

DETAIL OF THE MILLING OF THE "INTRECCIO VERTICALE" MODEL
 DETAIL DE LA MOULURE DU MODEL «INTRECCIO VERTICALE»

SEZIONE FRESATURA MOD. CITY 1,2,3 E MOD. INTRECCIO VERT.

Model CITY 1,2,3 milled section and VERTICAL INTRECCIO model
 Section moulure mod. CITY 1,2,3 et mod. INTRECCIO VERT.

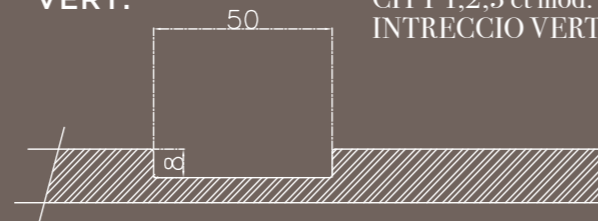

SEZIONI FRESATURA MOD. INTRECCIO ORIZZ.

Model INTRECCIO ORIZZ. milled section
 Section moulure mod. INTRECCIO ORIZZ.

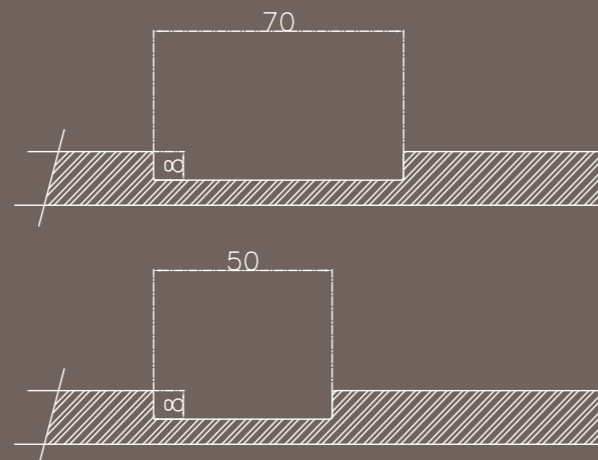

FINITURE



I diversi modelli di questa collezione possono, su richiesta, essere dotati di una serie di inserti inediti, in ACCIAIO o MDF, che ne moltiplicano esponenzialmente le interpretazioni stilistiche.

The different models of this collection can, on request, be equipped with a series of new steel or MDF plates, which exponentially multiply their stylistic interpretations.

Les differents models de cette collections, sur demande, peuvent accueillir plusieurs inserts inedits en acier ou MDF, qui en multiplient exponentiellement les interpretations stylistiques.

INSERTI IN ACCIAIO INOX STAINLESS STEEL PLATES INSERTS ACIER INOX



EFFETTO RUGGINE
 Rust effect
 Effet rouille

OTTONE
 Brass
 Laiton

ACCIAIO INOX
 Stainless steel
 Acier inox

EFFETTO BRUNITO
 Burnished effect
 Effet bruni

INSERTI IN MDF MDF INSERTS INSERTS MDF



EFFETTO FERRO OPACO
 Matt iron effect
 Effet fer opaque

EFFETTO CORTEN
 Corten effect
 Effet corten

EFFETTO GLITTER NERO
 Black glitter effect
 Effet glitter noir

EFFETTO BRUNITO LUCIDO
 Burnished effect
 Effet bruni brillant

EFFETTO FERRO LUCIDO
 Shiny iron effect
 Effet fer brillant



EFFETTO GLITTER BIANCO
 White glitter effect
 Effet glitter blanc

EFFETTO ORO OPACO
 Matt gold effect
 Effet or mat

EFFETTO RUGGINE
 Rust effect
 Effet rouille

EFFETTO SOFT TOUCH
 Soft touch effect
 Effet soft touch

EFFETTO MULTICOLOR
 Multicolor effect
 Effet multicolor



Nell'immagine a sinistra, il pannello "CARTOON 1" - laccato RAL 8019 - è abbinato a inserti in MDF effetto oro lucido, la maniglia H4 a rosetta quadrata è in cromo satinato.

In the image on the left, the "CARTOON 1" panel - RAL 8019 lacquered - is combined with MDF inserts with a shiny gold effect. The H4 handle with square metal cover is in satin chrome colour.

Dans l'image à gauche le panneau "CARTOON 1" - laqué RAL 8019 - est associé à inserts en MDF effet or brillant, la bequille H4 avec rosace carrée est chromé satiné.

CARTOON* Collection



IN CARTOON COLLECTION FORME VIRTUALI E IMMAGINARIE, SUGGERITE DAI DISEGNI ANIMATI DEGLI ANNI 30', DIVENTANO REALI GRAZIE ALLA RICERCA LAVORAZIONE DEI PANNELLI, LE CUI FRESATURE ESALTANO LA POETICA MATERICITÀ DEL LEGNO.

IN THE "CARTOON COLLECTION" VIRTUAL AND IMAGINARY FORMS, INFLUENCED BY THE ANIMATED DRAWINGS OF THE 30S, BECOME REAL THANKS TO THE SOPHISTICATED PROCESSING OF THE PANELS WHOSE MILLING EXALT THE POETIC MATERIALITY OF THE WOOD.

DANS LA GAMME CARTOON COLLECTION FORMES VIRTUELLES ET IMAGINAIRES, IMPRESSIONNÉES PAR LES DESSINS-ANIMÉS DES ANNÉES '30, DEVIENNENT REELS, GRACE AU TRAVAIL DES PANNEAUX, DONT LES RAINURES EXALTENT L'ESSENCE DU BOIS.



PERSONALIZZA LA TUA CARTOON SCEGLIENDO IL COLORE DEL PANNELLO E DELL'INSERTO CHE PIU' SI ADICCE AL TUO SPAZIO E ALLA TUA PERSONALITÀ.

Nell'immagine a destra, il pannello "CARTOON 2" - laccato RAL 9010 - è abbinato a inserti in MDF effetto ferro opaco. Maniglia H4 a rosetta quadrata - finitura bianco opaco RAL 9010.

CUSTOMIZE YOUR CARTOON CHOOSING THE COLOR OF THE PANEL AND INSERT THAT BEST SUITS YOUR SPACE AND YOUR PERSONALITY.

In the image on the right, the "CARTOON 2" panel - RAL 9010 lacquered - is mixed with inserts in MDF with an opaque iron effect. H4 handle and square metal cover - matt white finish - RAL 9010.

PERSONALISE TON PANNEAU CARTOON EN CHOISSANT LA COULEUR DU PANNEAU ET DE L'INSERT QUE S'ADAPTE AVEC TON ESPACE ET TA PERSONALITÉ.

Dans l'image a droite le panneau "CARTOON 2" - laqué RAL 9010 - est associé a inserts en Mdf effet fer mat. Bequille H4 avec rosace carrée - blanc mat RAL 9010.



C'è una crepa
in ogni cosa...
ed è da lì che filtra
LA LUCE Leonor Cabum

Personalizza la tua **CARTOON** scegliendo una delle 8 finiture proposte per la coppia degli inserti da abbinare al pannello

CUSTOMIZE YOUR CARTOON BY CHOOSING ONE OF THE 8 FINISHES PROPOSED FOR THE PAIR OF INSERTS TO BE COMBINED WITH THE PANEL

PERSONALIZE TON PANNEAU CARTOON EN CHOISSANT UNE ENTRE LES 8 FINITIONS POUR LA COUPLE DES INSERTS QUI VONT AVEC LE PANNEAU

SEZIONE FRESATURA MOD. CARTOON **CARTOON model milled section**
Section moulure mod. CARTOON

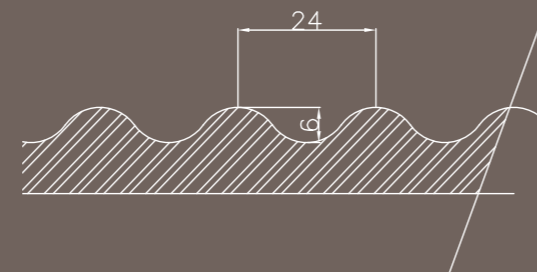

INSERTI IN MDF MDF INSERTS INSERTS MDF



EFFETTO MULTICOLOR
Multicolor effect
Effet multicolor



EFFETTO SOFT TOUCH 7022
Soft touch 7022 effect
Effet soft touch 7022



EFFETTO BRUNITO
Burnished effect
Effet bruni



EFFETTO FERRO LUCIDO
Polished iron effect
Effet fer lucide



EFFETTO FERRO OPACO
Matt iron effect
Effet fer opaque



EFFETTO GLITTER BIANCO
Glittered white effect
Effet glitter blanc



EFFETTO ORO LUCIDO
Polished gold effect
Effet or lucide



EFFETTO SOFT TOUCH 9005
Soft touch 9005 effect
Effet soft touch 9005

LISTEN* Collection



RAPPRESENTA SICURAMENTE UN CLASSICO DI GRANDE SUCCESSO TRA I MODELLI DELLA LINEA CONTEMPORANEA FIRMATI ALIAS.

ELEGANTE ED ESSENZIALE PUR SE DI GRANDE IMPATTO, IL DESIGN DELLE QUATTRO SOLUZIONI PROPOSTE CONFERISCE ALL'INGRESSO UNA SOFISTICATA IMPRONTA CONTEMPORANEA E RIGOROSA.

SURELY ONE OF THE MOST SUCCESSFULL CLASSIC MODEL AMONG THOSE OF THE ALIAS CONTEMPORARY LINE. ELEGANT AND ESSENTIAL BUT DEEPLY IMPACTING, THE DESIGN OF THE FOUR PROPOSED SOLUTIONS GIVES AN ALLURE OF ELEGANCE AND RIGOR TO THE HOME ENTRANCE.

IL REPRESENTE UN MODÈLE CLASIQUE ET DE GRANDE REUSSITE ENTRE LES MODÈLES DE LA GAMME CONTEMPORAINE SIGNÉE PAR ALIAS. ELEGANT ET ESSENTIEL MAIS QUATRE PUISSANT, LE DESIGN DES TROIS SOLUTIONS PROPOSÉES DONNE À L'ENTRÉE UNE EMPREINTE SOPHISTIQUEE ET RIGOUREUSE.

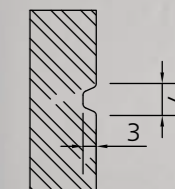

In questa immagine il celeberrimo modello "LISTEN 1", laccato RAL 7024 con maniglione fisso esterno in cromo satinato.

The image shows the famous model "LISTEN 1", RAL 7024, with matt chrome external fixed handle.

Dans cette image le notoir modèle "LISTEN 1", laqué Ral 7024 avec baton de marechal externe chromé satiné.

Versione del pannello
avvolgente carena

Panel that envelops and
covers the leaf profile

Version du panneau
couvrant la carène



**Modello "LISTEN 2" in rovere tabacco,
maniglia FENIX a rosetta quadrata
in cromo satinato.**

Model "LISTEN 2" tobacco oak,
FENIX handle with matt chrome square cover.

Modèle "LISTEN 2" en chene tabac, bequille
FENIX avec rosette carrée en chromé satiné.



**Modello "LISTEN 3" in rovere
pietra, maniglia FENIX a rosetta
quadrata in cromo satinato.**

Model "LISTEN 3" stone oak,
FENIX handle with matt chrome square cover.

Modèle "LISTEN 3" en chêne effet pierre, bequille
FENIX avec rosace carrée en chromé satiné.

**Versione del pannello
avvolgente carena**

Panel that envelops and
covers the leaf profile

Version du panneau
couvrant la carène



**Modello "LISTEN 4" laccato
RAL 1019, maniglia H4 a rosetta
quadrata - finitura grigio grafite.**

Model "LISTEN 4", RAL 1019, graphite grey H4
handle with square cover.

Modèle "LISTEN 4" laqué RAL 1019, bequille H4
avec rosace carrée finition grise graphite.





Modello "LISTEN 1"
in wengé con maniglione
esterno fisso cromo
satinato e serratura
motorizzata SMART.

Model "LISTEN 1", wengé, with matt
chrome external fixed handle and
SMART operated lock.

Modèle "LISTEN 1" wengé avec baton
de marechal externe fixe en chromé
satiné et serrure SMART.



PAIS * Collection

SEMPRE IN PERFETTO EQUILIBRIO TRA ESTETICA E FUNZIONALITÀ, SI IMPREZIOSISCE GRAZIE A INEDITI INSERTI CENTRALI IN MDF.

AI MODELLI DI GRANDE SUCCESSO "PAIS A111" E "PAIS LIGHT", SI AGGIUNGE OGGI "PAIS PICTURE".

In questo progetto d'interior il pannello "PAIS PICTURE", laccato grigio antracite con inserto in MDF effetto corten, è protagonista del design dello spazio tanto quanto i complementi d'arredo, anzi, "PAIS PICTURE" diventa complemento d'arredo - oltre che elemento che delimita lo spazio e lo protegge e ripara dall'esterno. La maniglia pordoi a rosetta tonda è in ottone lucido.

THE PERFECT BALANCE OF AESTHETIC AND FUNCTIONALITY IS NOW EMBELLISHED WITH MDF CENTRAL INSERTS. THE "PAIS PICTURE" MODEL JOINS THE ALREADY WELL KNOWN "PAIS A111" AND "PAIS LIGHT".

In this interior project, "PAIS PICTURE", lacquered anthracite grey with MDF insert corten effect, is not only a means to protect from the exterior but becomes part of the furniture itself. The handle is a brass pordoi model with round cover.

IL S'ENRICHIT GRACE A NOUVEAUX INSERTS CENTRAUX EN MDF, EN EQUILIBRE ENTRE ESTETIQUE ET FONCTIONNALITÉ. EN PLUS DES MODÈLES "PAIS A111" ET "PAIS LIGHT" ON AJOUTE LE NOUVEAU MODÈLE "PAIS PICTURE".

Dans ce projet le panneau "PAIS PICTURE" laqué gris anthracite avec insert Mdf effet corten est le protagoniste de l'espace autant que les meubles de la maison. En fait il devient lui meme partie de la decoration, il delimité l'espace et le protégé de l'exterieur. La bequille pordoi avec rosace ronde est en brass poli.



Modello "PAIS PICTURE"
laccato RAL 9010, con
fresatura orizzontale
e inserto effetto
verderame. Maniglia
FENIX a rosetta quadrata
in cromo satinato.



"PAIS PICTURE" RAL 9010, with
horizontal engraving and verdigris insert.
FENIX handle with matt chrome square cover.

Modèle "PAIS PICTURE" - laqué RAL 9010
avec moulure horizontale et insert
effet vert - de - gris. Bequille FENIX
avec rosace carrée en chromé satiné.



Modello "PAIS PICTURE"
laccato grigio antracite,
con fresatura
orizzontale e inserto
effetto oro opaco.
Maniglia OVALE a rosetta
tonda in ottone satinato.



"PAIS PICTURE" anthracite gris,
with horizontal engraving and matt gold insert.
Oval handle with matt brass round cover.

Modèle "PAIS PICTURE" - laqué gris anthracite
avec moulure horizontale et insert effet or mat.
Bequille oeuf avec rosace ronde en laiton satiné.

Personalizza la
tua PAIS PICTURE
scegliendo il
colore dell'inserto
che più si addice
al tuo spazio e alla
tua personalità

GLI INSERTI, INEDITI,
SONO IN MDF
MDF INSERTS
LES NOUVEAUX INSERTS
SON EN MDF

CUSTOMIZE YOUR PAIS PICTURE
BY CHOOSING THE INSERT
COLOUR THAT BEST SUITS
TO YOUR SPACE AND YOUR
PERSONAITY

PERSONNALISE TON PAIS
PICTURE EN CHOISSANT LA
COULEUR DE L'INSERT QUE
MIEUX S'ADAPTE À TON ESPACE
ET À TA PERSONNALITÉ



EFFETTO
ORO OPACO
Matt gold effect
Effet or mat



EFFETTO
VERDERAME
Verdigris effect
Effet vert-de-gris



EFFETTO
CORTEN
Corten effect
Effet corten



FINITURE

Modello "PAIS A111"
in teak con fresatura
orizzontale e fascia
in acciaio inox.
Maniglia H4 a rosetta
quadrata in cromo satinato.



"PAIS A111", teak finishing with horizontal
engraving and stainless steel strip. H4 handle
with matt chrome square cover.

Modèle "PAIS A111" en teak avec moulure
horizontale et bande en acier inox. Bequille H4
avec rosace carrée en chromé satiné.



Pannello "PAIS"
realizzato con mattoncini
di gres porcellanato
e fascia inox.
Maniglia H4 a rosetta
quadrata in cromo satinato.



"PAIS" panel with porcelain stoneware and flat
stainless steel strip. H4 handle with matt chrome
square cover.

Panneau "PAIS" produit avec petits briques en
grès porcelainé et bande inox. Bequille H4 avec
rosace carrée en chromé satiné.

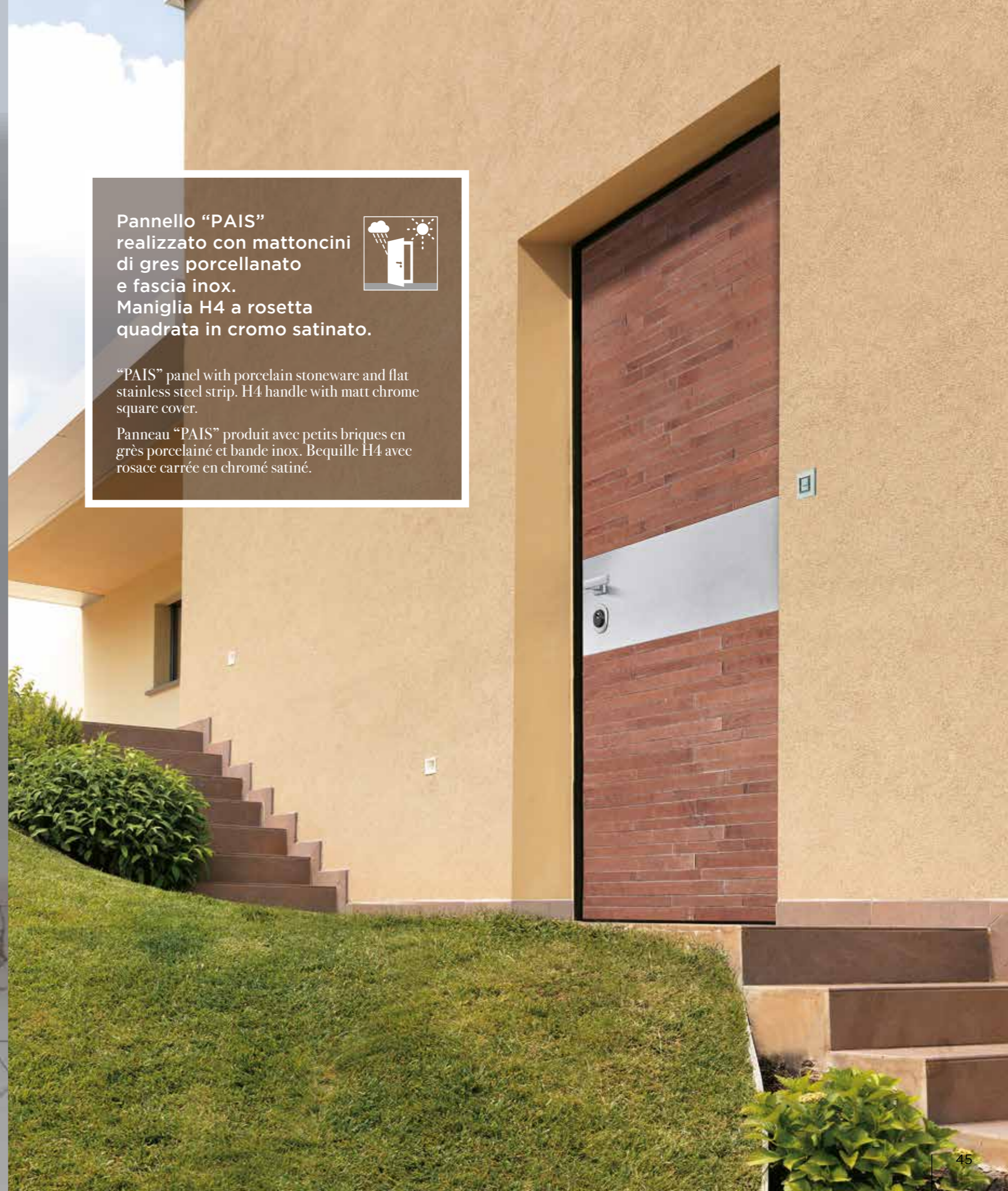

Modello "PAIS"
nella versione light
da 6 mm di
spessore, in laminato
larice matrix con fascia
in acciaio inox.
Maniglia FENIX a rosetta
quadrata in cromo satinato.



"PAIS" model, light version with a thickness
of 6 mm, matrix larch with stainless steel strip.
FENIX handle with matt chrome square cover.

Modèle "PAIS" dans la version light en 6 mm
d'épaisseur en melaminé matrix mélèze avec
bande en acier inox. Bequille FENIX avec
rosace carrée en chromé satiné.



Anche qui,
modello "PAIS"
nella versione
light da 6 mm
di spessore, in laminato
palissandro matrix con
fascia in acciaio inox.
Maniglia FENIX a rosetta
quadrata in cromo
satinato.



"PAIS" model, light version with a
thickness of 6 mm, matrix rose oak with
stainless steel strip. FENIX handle with
matt chrome square cover.

Encore le modèle "PAIS" dans la version
light en 6 mm d'épaisseur en melaminé
palissandre matrix avec bande en acier
inox. Bequille FENIX avec rosace carrée
en chromé satiné.



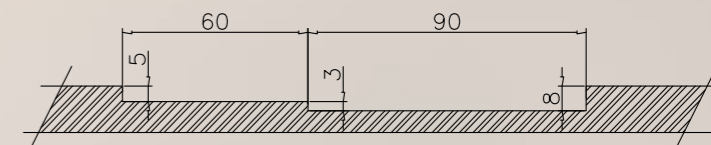

GIPSY*



È L'UNIONE DI GLAMOUR E MINIMALISMO, GRAZIE ALLA NUOVISSIMA LAVORAZIONE DELLA PANTOGRAFATURA. UN CONCEPT VERSATILE PER SPAZI DAL DESIGN ESSENZIALE, MA DECISO.

In questa immagine, il pannello "GIPSY" è laccato RAL 7038, la maniglia FENIX a rosetta quadrata è in cromo satinato.

THE BRAND NEW ENGRAVING GIVES THIS MODEL THE PERFECT MIX OF GLAMOUR AND MINIMALISM. IT REPRESENTS A VERSATILE CONCEPT SUITABLE FOR PLACES WITH AN ESSENTIAL BUT EVEN CONFIDENT DESIGN.

The image shows the "GIPSY" model, RAL 7038 with FENIX handle with matt chrome square cover.

CE MODELE EST L'ENSEMBLE DE GLAMOUR ET MINIMALISME, GRACE A UNE NOUVELLE MOULURE. UN CONCEPT POLYVALENT POUR UN DESIGN ESSENTIEL MAIS DEFINI.

Dans cette image le panneau "GIPSY" est laqué RAL 7038, la bequille FENIX avec rosace carrée est chromé satiné.

In questa immagine, il modello "MARBLE 3" è rivestito di gres porcellanato finitura pietra gray.

La fascia è in acciaio inox, la finitura della maniglia H4 a rosetta quadrata, è in grigio grafite.

This image shows the "MARBLE 3" panel, stone grey porcelain stoneware with a stainless steel strip. The H4 handle with square cover is graphite grey.

Dans cette image le modèle "MARBLE 3" est produit avec grès porcelainé finition pierre gray. La bande est en acier inox au fil du panneau. La finition de la bequille H4 avec rosace carrée est gris graphite.



MARBLE* Collection



RAFFINATA ED ELEGANTE, QUESTA NUOVA COLLEZIONE FIRMATA ALIAS PROPONE PANNELLI CARICHI D'INDIVIDUALITÀ, DAL FORTE IMPATTO DECORATIVO PUR NELLA SUA RIGOROSA MATERICITÀ.

LE SUPERFICI LUMINOSE E LE RICERCATE TEXTURE DEL GRES GIOCANO CON GLI ELEMENTI TECNICO DECORATIVI IN UN PRECISO STUDIO DI EQUILIBRI, PER UNA COLLEZIONE DALL'AMPIA VERSATILITÀ E DALLA SPICCATO ELEGANZA STILISTICA.

REFINED AND ELEGANT, THIS NEW ALIAS COLLECTION PROPOSES PANELS FULL OF INDIVIDUALITY, STRONGLY IMPACTING FROM THE DECORATIVE POINT OF VIEW BUT STRICTLY MATERIAL. THE BRIGHT SURFACES AND SOPHISTICATED TEXTURES OF THE STONEWARE PERFECTLY BALANCE WITH DECORATIVE AND TECHNICAL ELEMENTS CREATING A VERSATILE COLLECTION FULL OF STYLE.

RAFFINEE' ET ELEGANTE CETTE NOUVELLE COLLECTION SIGNEE PAR ALIAS PROPOSE PANNEAUX TRES PARTICULIERS, AYANT UN IMPACT DECORATIF SIGNIFICATIF. LES SURFACES LUMINEUSES ET LES TEXTURES DU GRES JOUENT AVEC LES ELEMENTS DECORATIFS POUR UNE COLLECTION TRES POLYVALENTE ET ELEGANTE.

Nell'immagine a destra, il modello "MARBLE 1" si veste di gres porcellanato finitura calacatta gold extra. L'inserto in acciaio brunito e la maniglia H4 sono coordinate al telaio finitura brunitech.

The image on the right shows the model "MARBLE 1", porcelain stoneware, "calacatta gold extra" finishing. The flat strip burnished steel and the H4 handle are coordinated with the brunitech frame.

Dans l'image à droite le modèle "MARBLE 1" devient grés porcelainé finition "calacatta gold extra". L'insert en acier poli au fil du panneau et la bequille H4 sont coordonnés à la huisserie brunitech.



Nell'immagine a sinistra, invece, il modello "MARBLE 2" indossa gres porcellanato finitura onice venus. L'inserto in acciaio inox e la maniglia H4 sono coordinate al telaio finitura alluminio.

The image on the left shows the model "MARBLE 2", porcelain stoneware, "onice venus" finishing. The flat stainless steel strip and the H4 handle are coordinated with the aluminum frame.

Dans l'image à gauche le modèle "MARBLE 2" devient grés porcelainé finition "onice venus". L'insert en acier inox et la bequille H4 sont coordonnés à la huisserie aluminium.





CARGO Collection



PANNELLO PANTOGRAFATO CARGO, LACCATO RAL 9010, CON FASCIA IN ACCIAIO INOX FILO PANNELLO. IL POMOLO OVALE FISSO È IN CROMO SATINATO, LA SERRATURA MOTORIZZATA "SMART".

THE CARGO PANEL, TANGANYIKA LAQUERED RAL 9010 STAINLESS STEEL STRIP FLAT TO THE PANEL. THE OVAL FIXED KNOB IS MATT CHROME AND THE LOCK IS OPERATED SMART.

PANNEAU MOULURE' CARGO EN TANGANICA LAQUE' RAL 9010 AVEC BANDE EN ACIER INOX AU FIL DU PANNEAU. LE POMMEAU OEUF FIXE EST CHROME' SATINE', LA SERRURE MOTORISEE SMART.

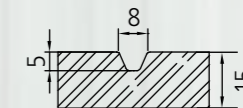

Pannello pantografato "CARGO" in MDF laccato RAL 7024, con fascia in acciaio inox. Maniglia H4 a rosetta quadrata in cromo satinato abbinata al quadrato.

"CARGO" panel, MDF laquered RAL 7024 with stainless steel strip. H4 handle with matt chrome square cover coordinated with the square cylinder protection.

Panneau mouluré "CARGO" en MDF laqué RAL 7024 avec bande en acier inox. Bequille H4 avec rosace carrée en chromé satiné avec défendeur carré.



Pannello "CARGO" con fresature pantografate in MDF laccato rosso RAL 3013. Maniglione fisso in cromo satinato.

Engraved "CARGO" panel, MDF laquered RAL 3013 with matt chrome external fixed handle.

Panneau "CARGO" mouluré en MDF laqué RAL 3013. Baton de marchal fixe en chromé satiné.



QUADRANTE

PANNELLO "QUADRANTE" IN LAMINATO BIANCO MATRIX CON MODULO CENTRALE IN METACRILATO MOKA. MANIGLIA H4 A ROSETTA QUADRATA IN CROMO SATINATO.

"QUADRANTE" PANEL IN LAMINATED WHITE MATRIX WITH CENTRAL MODULE IN METHACRYLATE MOKA. H4 HANDLE WITH MATT CHROME SQUARED SUPPORT.

PANNEAU «QUADRANTE» EN MÉLAMINÉ MATRIX BLANC ET MODULE CENTRAL EN MÉTHACRYLATE COULEUR MOKA. POIGNÉE H4 AVEC ROSACE CARRÉE EN CHROMÉ SATINÉ.

Pannello "QUADRANTE" in laminato cenere tranché con i tre moduli a venatura orizzontale. Maniglia FENIX a rosetta quadrata in cromo satinato.

"QUADRANTE" panel in laminated cinder tranché with 3 modules with horizontal grain module. FENIX handle with matt chrome squared support.

Panneau «QUADRANTE» en mélaminé cendre tranché à trois modules à veinures horizontales. Poignée FENIX avec rosace carrée en chromé satiné.



Pannello "QUADRANTE" in metacrilato nero con modulo centrale facestone vulcano. Maniglia H4 a rosetta quadrata in cromo satinato completa di pomolo per dispositivo block coordinato.

"QUADRANTE" panel in black methacrylate with central module Facestone Vulcano. H4 handle with matt chrome squared support, complete with coordinated block device.

Panneau «QUADRANTE» en méthacrylate noir avec module central en Facestone Vulcano. Poignée H4 avec rosace carrée en chromé satiné avec dispositif de verrouillage coordonné.

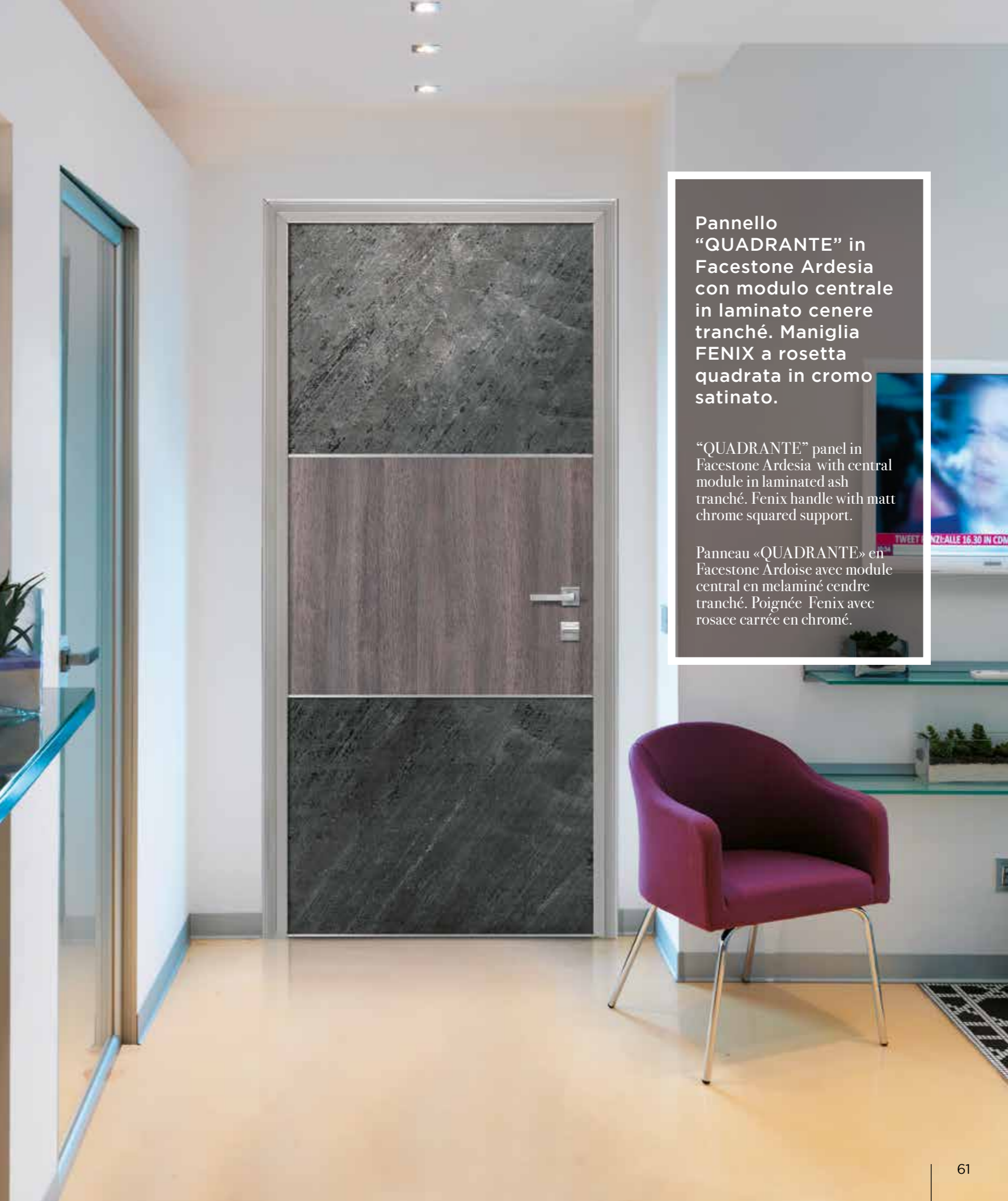

Pannello "QUADRANTE" in Facestone Ardesia con modulo centrale in laminato cenere tranché. Maniglia FENIX a rosetta quadrata in cromo satinato.

"QUADRANTE" panel in Facestone Ardesia with central module in laminated ash tranché. Fenix handle with matt chrome squared support.

Panneau «QUADRANTE» en Facestone Ardoise avec module central en mélaminé cendre tranché. Poignée Fenix avec rosace carrée en chromé.

MOTION



PANNELLO MOTION IN ROVERE TINTO WENGÉ CON INSERTO IN ALLUMINIO E POMOLO FISSO ESTERNO IN CROMO SATINATO.

MOTION PANEL IN WENGÉ WITH ALUMINIUM INSERT. EXTERNALLY IT IS SET A FIXED MATT CHROME KNOB.

PANNEAU MOTION EN CHÊNE WENGÉ AVEC INSERT ALU. SUR LE CÔTÉ EXTÉRIEUR UNE POIGNÉE EN CHROMÉ SATINÉ.

Pannello "MOTION"
laccato bianco RAL 9010
con pomolo fisso in
cromo satinato.

"MOTION" panel in white laquered
RAL 9010. Fixed handle with matt
chrome knob.

Panneau «MOTION» blanc RAL 9010
avec une poignée en chromé satiné.

PLANAR



**PANNELLO "PLANAR" LACCATO
RAL 7035 LUCIDO, INSERTO CENTRALE
FACESTONE VULCANO.
MANIGLIA H4 A ROSETTA QUADRA
TA IN CROMO SATINATO
COMPLETA DI POMOLO PER DI
SPOSITIVO BLOCK COORDINATO.**

"PLANAR" PANEL RAL 7035 LAC
QUERED, CENTRAL INSERT FACES
TONE VULCANO. H4 HANDLE WITH
MATT CHROME SQUARED SUPPOR
T COMPLETE WITH COORDINATED
BLOCK DEVICE.

PANNEAU «PLANAR» LAQUÉ RAL
7035, INSERT CENTRAL FACESTONE
VULCANO. POIGNÉE H4 AVEC RO
SACE CARRÉE EN CHROMÉ SATINÉ
AVEC DISPOSITIF DE VERROUIL
LAGE COORDONNÉ.

LINEA



PANNELLO "LINEA" IN ROVERE ORIZZONTALE COLOR TABACCO CON INSERTO IN ACCIAIO INOX. MANIGLIA H4 A ROSETTA QUADRATA IN CROMO SATINATO.

"LINEA" PANEL IN HORIZONTAL OAK TOBACCO COLOR WITH A SHEET INSERT. H4 HANDLE WITH MATT CHROME SQUARED SUPPORT.

PANNEAU «LINEA» EN CHÊNE TABAC À VEINURES HORIZONTALES AVEC INSERT CENTRAL EN ACIER INOXYDABLE. POIGNÉE H4 AVEC ROSETTE CARRÉE EN CHROMÉ SATINÉ.

INOUT Collection



PANNELLO "INOUT 1" LACCATO BIANCO RAL 9010. IL RIVESTIMENTO È CARATTERIZZATO DAL BASSORILIEVO CENTRALE PANTOGRAFATO. MANIGLIA FENIX A ROSETTA QUADRATA IN CROMO SATINATO.

"INOUT 1" PANEL WHITE RAL 9010. THE PANEL IS FEATURED BY A CENTRAL PANTOGRAPHED BAS-RELIEF. FENIX HANDLE WITH MATT CHROME SQUARED SUPPORT.

PANNEAU «INOUT 1» BLANC RAL 9010. LE REVÊTEMENT EST CARACTÉRISÉ PAR UN BAS-RELIEF PANTOGRAPHÉ. POIGNÉE H4 AVEC ROSACE CARRÉE EN CHROMÉ SATINÉ.



Pannello "INOOUT 2" laccato grigio RAL 7036. Il rivestimento è caratterizzato dal bassorilievo centrale pantografato. Maniglia H4 a rosetta quadrata in cromo satinato.

"INOOUT 2" panel lacquered grey RAL 7036. The panel is featured by a central pantographed bas-relief. H4 handle with matt chrome squared support.

Panneau «INOOUT 2» gris RAL 7036. Le revêtement est caractérisé par un bas-relief pantographé. Poignée H4 avec rosace carrée en chromé satiné.



SQUARE



PANNELLO SQUARE IN ROVERE ORIZZONTALE COLOR TABACCO. MANIGLIA H4 A ROSETTA QUADRATA FINITURA GRIGIO GRAFITE.

SQUARE PANEL HORIZONTAL TOBACCO OAK. H4 HANDLE WITH GRAPHITE GREY SQUARE COVER.

PANNEAU SQUARE EN CHENE HORIZONTAL TEINTE' TABAC. BEQUILLE H4 AVEC ROSACE CARREE FINITION GRIS GRAPHITE.





MOUSE



PANNELLO "MOUSE" LACCATO BIANCO RAL 9010 CON MODULO CENTRALE IN LAMINATO LARICE MATRIX. MANIGLIA H4 A ROSETTA QUADRATA IN CROMO SATINATO.

"MOUSE" PANEL LAQUERED WHITE RAL 9010 WITH CENTRAL MODULE IN LAMINATED MATRIX LARCH. H4 HANDLE WITH MATT CHROME SQUARED SUPPORT.

PANNEAU «MOUSE» BLANC LAQUÉ RAL 9010 AVEC MODULE CENTRAL EN MÊLÈZE MATRIX. POIGNÉE H4 AVEC ROSACE CARRÉE EN CHROMÉ SATINÉ.



ONDA



PANNELLO "ONDA" CON MODULO LATO CERNIERA LACCATO BIANCO RAL 9010 E MODULO LATO SERRATURA IN LAMINATO TERRA TRANCHÉ. MANIGLIA H4 A ROSETTA QUADRATA IN CROMO SATINATO COMPLETA DI POMOLO PER DISPOSITIVO BLOCK COORDINATO.

"ONDA" PANEL WITH HINGE SIDE RAL 9010 MODULE AND LOCK SIDE WITH LAMINATED EARTH TRANCHÉ MODULE. H4 HANDLE WITH MATT CHROME SQUARED SUPPORT COMPLETE WITH COORDINATED BLOCK DEVICE.

PANNEAU «ONDA» AVEC MODULE CÔTÉ PAUMELLE RAL 1019 ET MODULE CÔTÉ SERRURE EN MÉLAMINÉ TERRE TRANCHÉ. POIGNÉE H4 AVEC ROSACE CARRÉE EN CHROMÉ SATINÉ AVEC DISPOSITIF DE VERROUILLAGE COORDONNÉ.

CACTUS



PANNELLO "CACTUS" IN ROVERE ORIZZONTALE TINTO MIELE CON VETRO SATINATO BIANCO. MANIGLIA H4 A ROSETTA QUADRATA IN CROMO SATINATO COMPLETA DI POMOLO PER DISPOSITIVO BLOCK COORDINATO.

"CACTUS" PANEL IN HORIZONTAL HONEY OAK WITH MATT WHITE GLASS. H4 HANDLE WITH MATT CHROME SQUARED SUPPORT COMPLETE WITH COORDINATED BLOCK DEVICE.

PANNEAU «CACTUS» EN CHÊNE MIEL À VEINURES HORIZONTALES AVEC VERRE BLANC OPAQUE. POIGNÉE H4 AVEC ROSACE CARRÉE EN CHROMÉ SATINÉ AVEC DISPOSITIF DE VERROUILLAGE COORDONNÉ.



NINE



PANNELLO IN ROVERE ORIZZONTALE
COLOR PIETRA CON VETRO SATINATO
BIANCO. MANIGLIA H4 A ROSETTA QUADRATA
IN CROMO SATINATO.

“NINE” PANEL IN HORIZONTAL OAK STONE COLOR
WITH MATT WHITE GLASS. H4 HANDLE WITH
MATT CHROME SQUARED SUPPORT.

PANNEAU «NINE» EN CHÊNE PIERRE À VEINURES
HORIZONTALES AVEC VERRE BLANC OPAQUE.
POIGNÉE H4 AVEC ROSACE CARRÉE EN CHROME
SATINÉ.

Pannello "NINE"
in rovere orizzontale
color pietra con
vetro satinato bianco.
Maniglia FENIX a
rosetta quadrata in
cromo satinato.

"NINE" panel in horizontal oak
stone color with matt white glass.
FENIX handle with matt chrome
squared support.

Panneau «NINE» en chêne pierre
à veinures horizontales avec verre
blanc opaque. Poignée FENIX avec
rosace carrée en chromé satiné.



VELA



PANNELLO "VELA"
LACCATO BIANCO
RAL 9010 CON VETRO
SATINATO BIANCO.
MANIGLIA FENIX A
ROSETTA QUADRATA
IN CROMO SATINATO.

"VELA" PANEL RAL 9010
WHITE WITH MATT WHITE
GLASS. FENIX HANDLE
WITH MATT CHROME
SQUARED SUPPORT.

PANNEAU «VELA» BLANC
RAL 9010 AVEC VERRE
BLANC OPAQUE. POIGNÉE
FENIX AVEC ROSACE CAR-
RÉE EN CHROMÉ SATINÉ.



MAP



PANNELLO "MAP" LACCATO BIANCO OPACO RAL 9010
CON VETRO SATINATO BIANCO. MANIGLIA FENIX A
ROSETTA QUADRATA IN CROMO SATINATO.

"MAP" PANEL OPAQUE RAL 9010 WITH MATT WHITE GLASS.
FENIX HANDLE WITH MATT CHROME SQUARED SUPPORT.

PANNEAU «MAP» BLANC RAL 9010 SATINÉ AVEC VERRE
BLANC OPAQUE. POIGNÉE FENIX AVEC ROSACE CARRÉE EN
CHROMÉ SATINÉ.





TEN



PANNELLO "TEN" IN ROVERE ORIZZONTALE COLOR PIETRA CON VETRO SATINATO BIANCO. MANIGLIA H4 A ROSETTA QUADRATA IN CROMO SATINATO.

"TEN" PANEL IN HORIZONTAL OAK STONE COLOR WITH MATT WHITE GLASS. H4 HANDLE WITH MATT CHROME SQUARED SUPPORT.

PANNEAU «TEN» EN CHÊNE PIERRE À VEINURES HORIZONTALES AVEC VERRE BLANC OPAQUE. POIGNÉE H4 AVEC ROSACE CARRÉE EN CHROMÉ SATINÉ.



OVAL



PANNELLO "OVAL" LACCATO BIANCO RAL 9010 CON VETRO SATINATO BIANCO. MANIGLIA H4 A ROSETTA QUADRATA IN CROMO SATINATO COMPLETA DI POMOLO PER DISPOSITIVO BLOCK COORDINATO.

"OVAL" PANEL RAL 9010 WITH MATT WHITE GLASS. H4 HANDLE WITH MATT CHROME SQUARED SUPPORT COMPLETE WITH COORDINATED BLOCK DEVICE.

PANNEAU «OVAL» BLANC RAL 9010 AVEC VERRE BLANC OPAQUE. POIGNÉE H4 AVEC ROSACE CARRÉE EN CHROMÉ SATINÉ AVEC DISPOSITIF DE VERROUILLAGE COORDONNÉ.



“TRADITION”

ELEMENTI INCONFONDIBILI E INTRAMONTABILI, PERFEZIONATI DALLA NATURA E DA UNA CONTINUA RICERCA. L'ESSENZA E IL COLORE DEL LEGNO, AUTENTICO RAPPRESENTANTE DI STILE PER UN RAFFINATO EQUILIBRIO TRA IERI E OGGI. LA LINEA TRADITION, CALDA ED ESSENZIALE IN OGNI SUO DETTAGLIO.

Unmistakable and timeless elements perfected by nature and continuous research. The essence and color of wood, authentic representative of style for a refined balance between yesterday and today. The Tradition line, warm and essential in every detail

Eléments uniques et intemporels, améliorés par la nature et par une recherche constante. L'essence et la couleur du bois, authentique symbole du style pour un raffiné équilibre entre hier et aujourd'hui. La ligne TRADITION, chaude et essentielle

In questa immagine
il modello
"RADIANT R118"
laccato RAL 1013.
La maniglia FENIX
a rosetta quadrata
è in cromo satinato.

In this image the "RADIANT R118"
model lacquered RAL 1013.
The FENIX handle with square
metal cover is in satin chrome.

Dans cette image le model
"RADIANT R118" laqué RAL 1013.
La Bèquille FENIX avec rosace carré
est en chromé satiné.

Versione del pannello
avvolgente carena

Hull wrapping
panel version

Version du panneau
couvrant le profil



RADIANT * Collection



LA NUOVA LINEA DI PANNELLI PANTOGRAFATI È CARATTERIZZATA DA AMPIE, ELOQUENTI RAFFINATISSIME FRESATURE CON PROFILI ASIMMETRICI CHE CONFERISCONO ELEGANZA E RAFFINATEZZA AI PANNELLI SIA IN ESSENZA NATURALE A VISTA CHE AI PANNELLI LACCATI. DESIGN DAL SEGNO MATERICO E RAZIONALISTA IN UN SAPIENTE EQUILIBRIO TRA CLASSICO E CONTEMPORANEO.

THE NEW LINE OF PANTOGRAPHED PANELS IS CHARACTERIZED BY LARGE, ELOQUENT AND REFINED WHITE ASYMMETRICAL PROFILE MILLED THAT GIVE ELEGANCE AND REFINEMENT TO THE PANELS BOTH IN NATURAL WOOD AND LACQUERED PANELS. DESIGN WITH A MATERIAL AND RATIONALIST SIGN IN A SKILFUL BALANCE BETWEEN CLASSIC AND CONTEMPORARY.

LA NOUVELLE LIGNE DE PANNEAUX MOULURES EST CARACTERISEE PAR LARGES, ELOQUENTES ET RAFFINEES MOULURES AVEC PROFIL ASIMÉTRIQUE QUI CONFÈRENT ELEGANCE ET SOPHISTICATION AUX PANNEAUX, SOIT EN BOIS, SOIT LAQUES. DESIGN AU TRAIT CONCRET ET RATIONNEL DANS UN SAGE EQUILIBRE ENTRE CLASSIQUE ET CONTEMPORAIN.

Modello "RADIANT R116"
in okoumé tinto noce
medio.
La maniglia H4 quadrata
è in cromo satinato.

"RADIANT R116" okoumé
dyed medium walnut model.
The square H4 handle is
in satin chrome.

Model "RADIANT R116" en
okoumé teinté noyer moyen.
La béquille H4 carrée est en
chromé satiné.

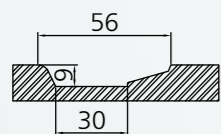

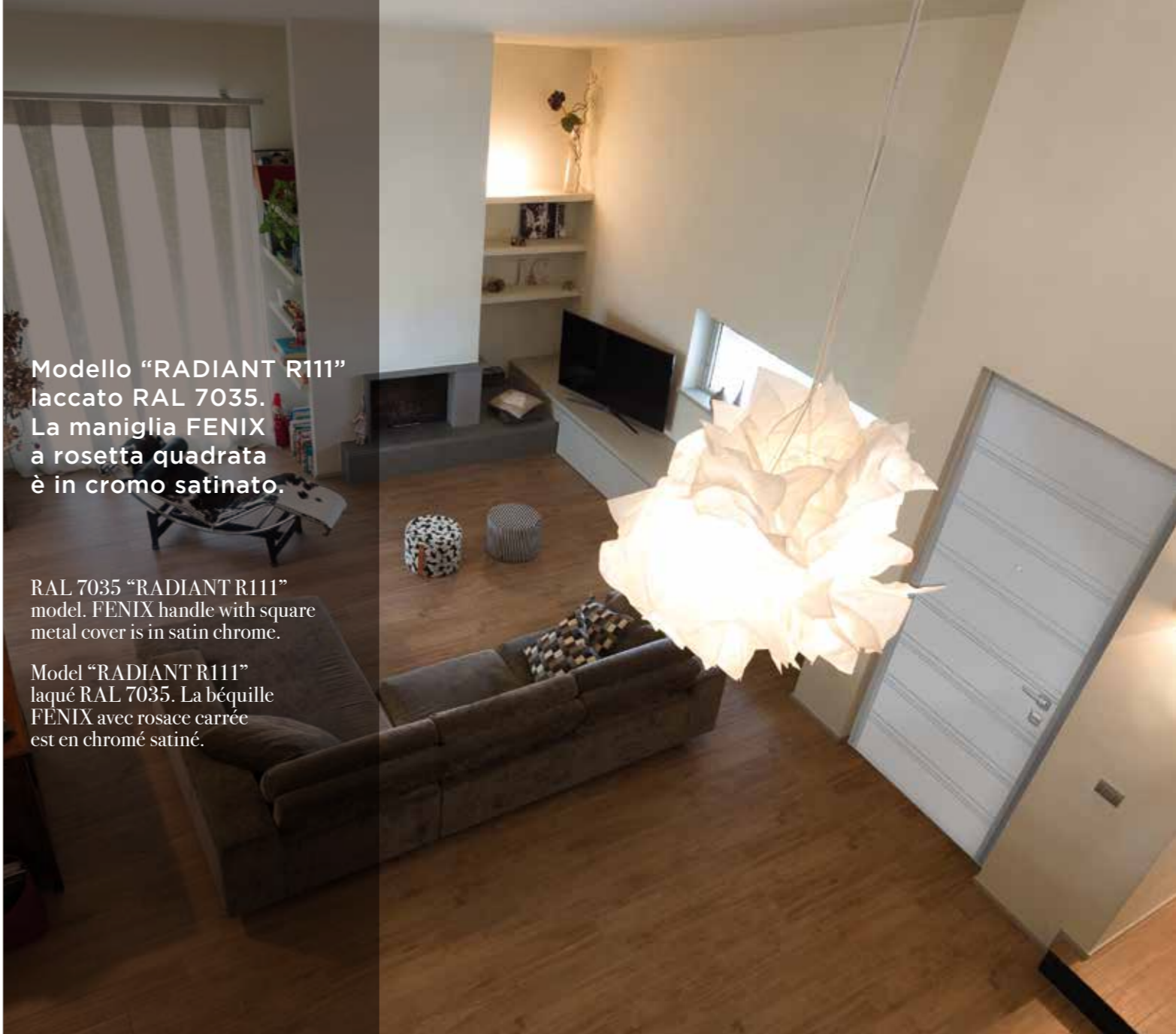

Modello "RADIANT R111"
laccato RAL 7035.
La maniglia FENIX
a rosetta quadrata
è in cromo satinato.

RAL 7035 "RADIANT R111"
model. FENIX handle with square
metal cover is in satin chrome.

Model "RADIANT R111"
laqué RAL 7035. La béquille
FENIX avec rosace carrée
est en chromé satiné.





Modello "RADIANT R116"
laccato RAL 7023.
La maniglia FENIX
a rosetta quadrata
è in cromo satinato.

Model "RADIANT R116"
lacquered RAL 7023.
The FENIX handle with square
metal cover is in satin chrome.

Model "RADIANT R116"
laqué RAL 7023.
La béquille FENIX avec rosace
carrée est en chromé satiné.

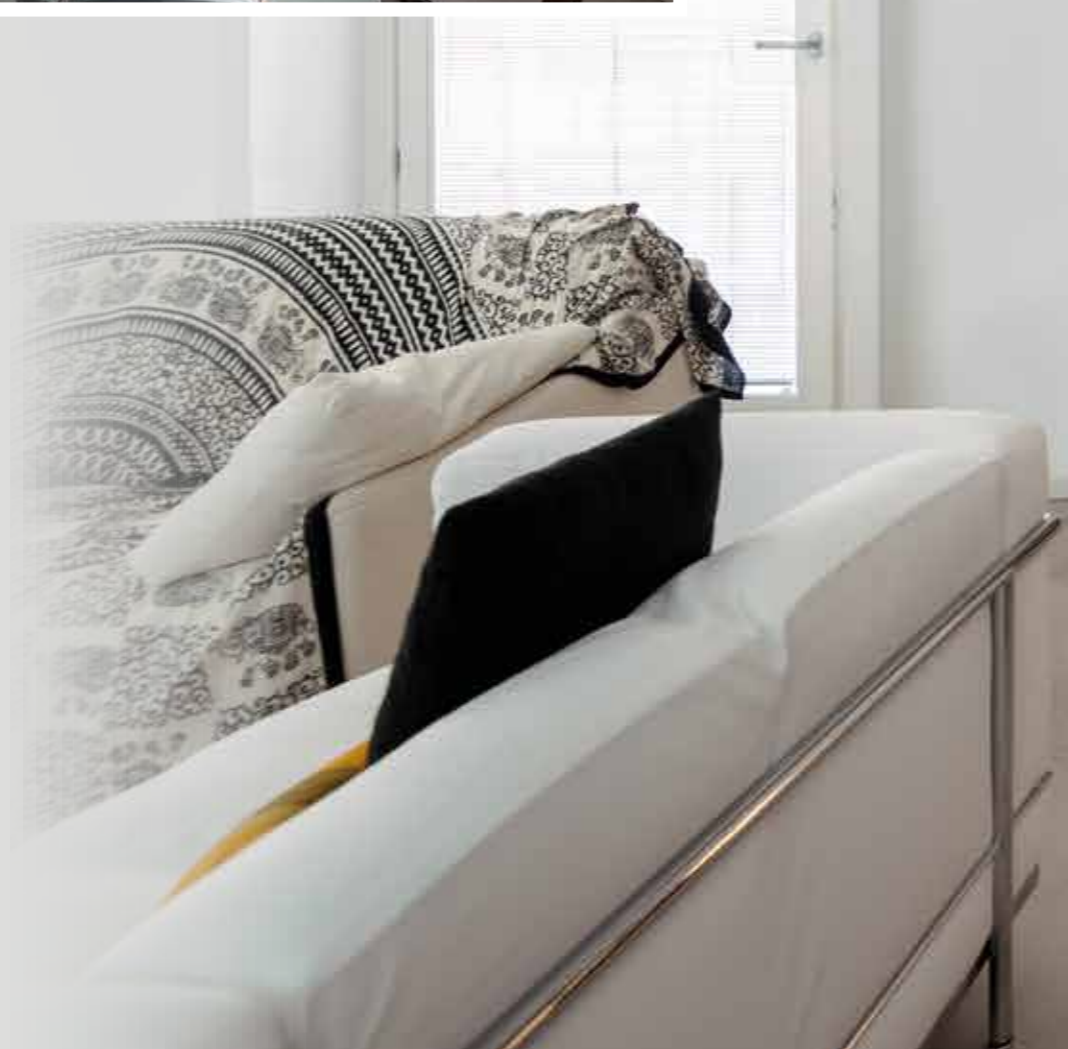

Modello
 "RADIANT R114"
 laccato RAL 7031.
 La maniglia FENIX
 a rosetta quadrata
 è in cromo satinato
 come il defender
 quadrato.

Model "RADIANT R114"
 lacquered RAL 7031.
 The FENIX handle with
 square metal cover is in satin
 chrome as the square defender.

Model "RADIANT R114"
 laqué RAL 7031.
 La béquille FENIX avec
 rosace carrée est en chromé
 satiné comme le protecteur
 anti-perceage carré.

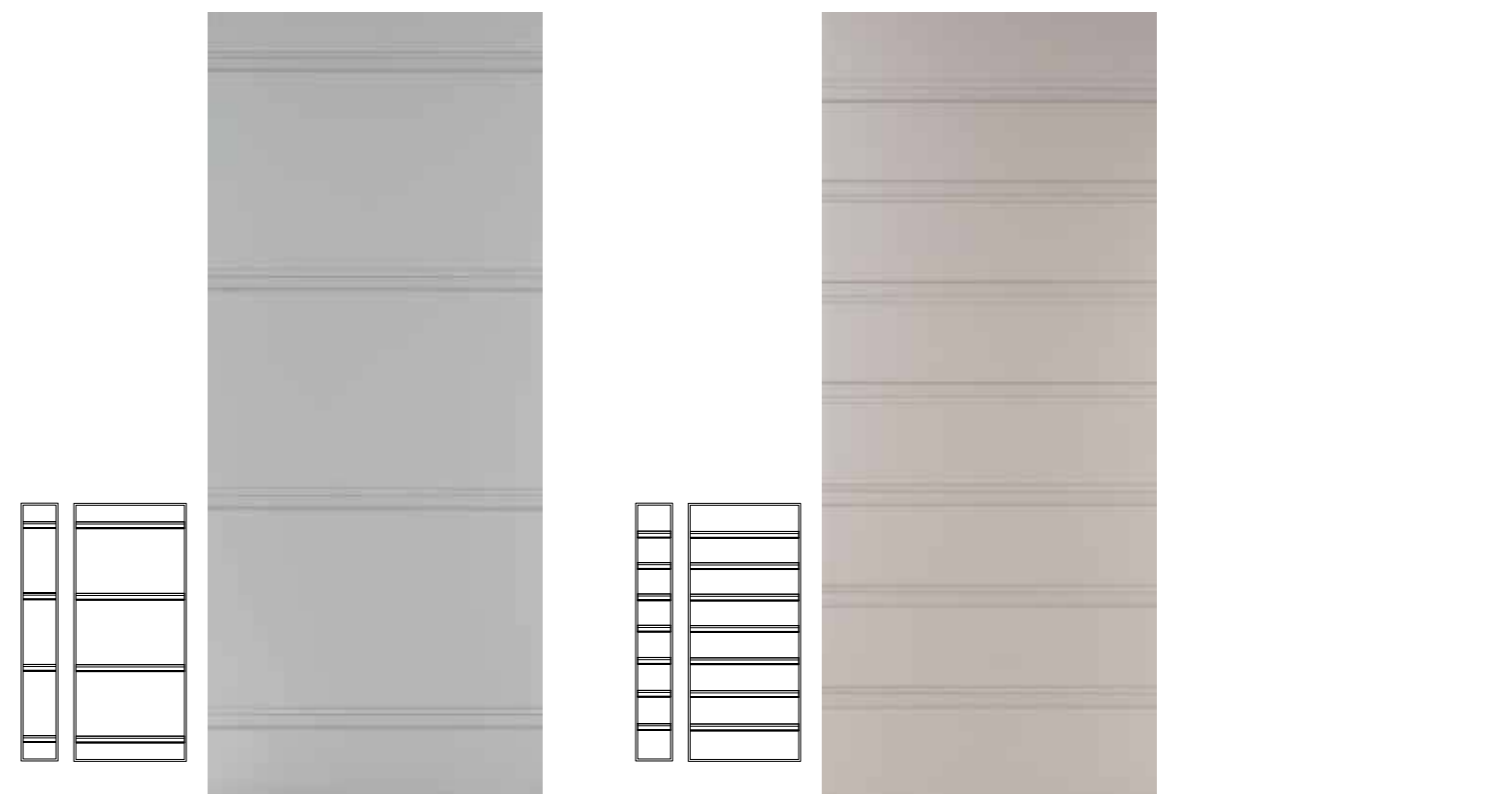

RADIANT MOD. R110

RADIANT MOD. R111*



RADIANT MOD. R114

RADIANT MOD. R112*

*LE FRESATURE
 DEI MODELLI
 R111 E R112
 - IN FUNZIONE
 DELL'ALTEZZA
 DELLE PORTE -
 POSSONO ESSERE
 INTERROTTE IN
 CORRISPONDENZA
 DEI FORI DELLA
 MANIGLIA

*The milling of models
 R111 and R112 according to
 the height of the doors can
 be interrupted at the holes
 of the handles

*Les moulures des models
 R111 et R112 - en fonction de
 la hauteur - peuvent être
 coupées en correspondance
 des trous de la béquille



RADIANT MOD. R113

RADIANT MOD. R115



RADIANT MOD. R117

RADIANT MOD. R118



RADIANT MOD. R116

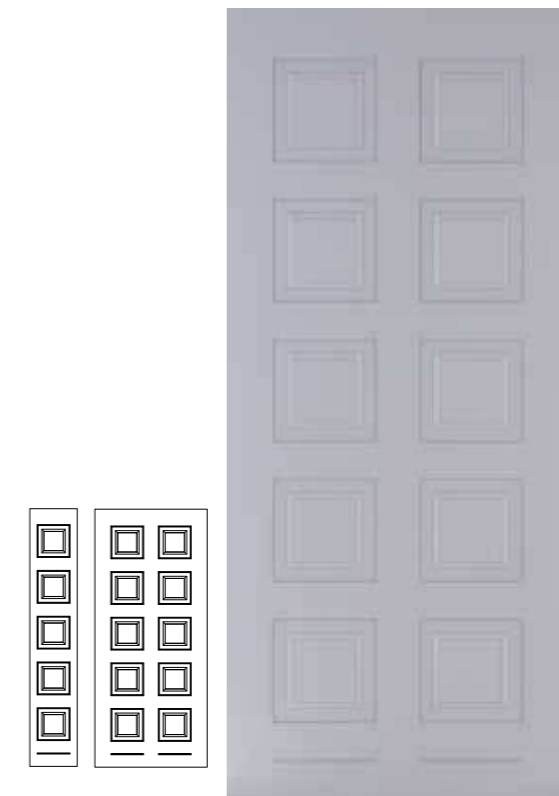

RADIANT MOD. R119

TUTTI I MODELLI DI
QUESTA COLLEZIONE
POSSONO ESSERE
PRODOTTI SIA IN
DIMENSIONI STANDARD
CHE FUORI MISURA E
ABBINATI ALLA LORO
ANTA SECONDARIA
NEL CASO DEI MODELLI
DUO E DOUBLE

All the models in this collection can
be produced both in standard and
oversized dimensions, and combined
with their secondary door in the case
of the DUO and DOUBLE models.

Tous les modèles de cette collection
peuvent être produits soit en mesures
standard, soit pour mesures différentes
et combinés à leur deuxième vantail en
cas de porte DUO et DOUBLE

DIAMANTE Collection



PANNELLO IN LEGNO PANTOGRAFATO A FIBRE PARALLELE A 90° A DOPPIO STRATO NOBILE. SPESSORE 15 MM

WOOD PANTOGRAPHED PANEL - DIAMANTE. DOUBLE NOBLE LAYER, 90° PANTOGRAPHED PANELS. 15 MM THICKNESS

PANNEAU EN BOIS PANTOGRAPHÉ À FIBRES PARALLÈLES À 90° - DOUBLE COUCHE. ÉPAISSEUR 15 MM

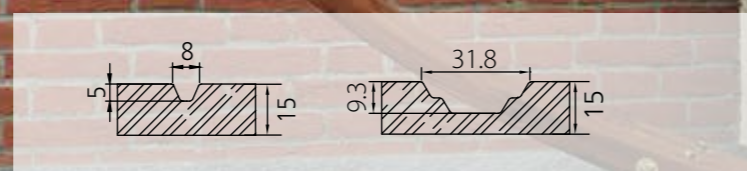

DIAMANTE MOD. A105

DIAMANTE MOD. A106

DIAMANTE MOD. A115



DIAMANTE MOD. A113

DIAMANTE MOD. A117

TUTTI I MODELLI
DI QUESTA COLLEZIONE
POSSONO ESSERE
PRODOTTI SIA IN
DIMENSIONI STANDARD
CHE FUORI MISURA E
ABBINATI ALLA LORO ANTA
SECONDARIA NEL CASO
DEI MODELLI DUO
E DOUBLE.

All the models in
this collection can
be produced both in
standard and oversized
dimensions, and
combined with their
secondary door in the
case of the DUO
and DOUBLE models.

Tous les models
de cette collection
peuvent être produit
soit en mesures
standard, soit pour
mesures différentes
et combinés à leur
deuxième vantail en
cas de porte DUO
et DOUBLE

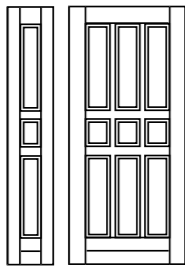

DIAMANTE MOD. A123

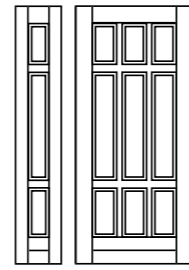

DIAMANTE MOD. A125

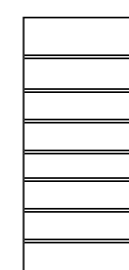

DIAMANTE MOD. A111*

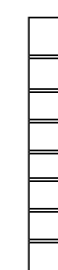

DIAMANTE MOD. A112

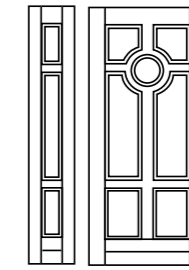

DIAMANTE MOD. A107

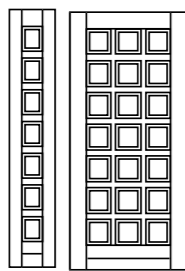

DIAMANTE MOD. A127

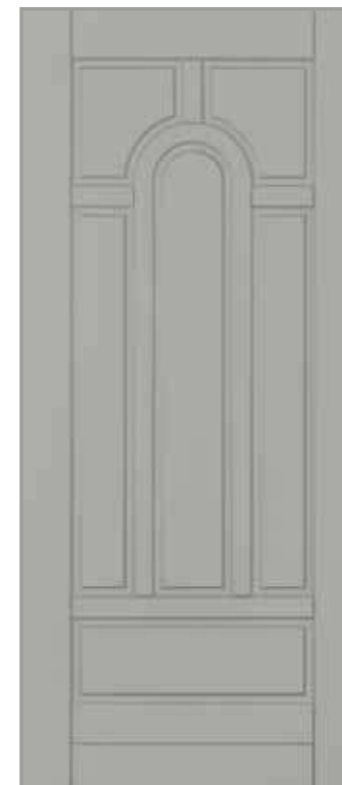
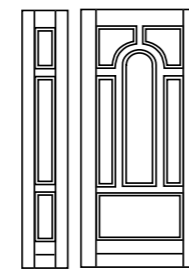

DIAMANTE MOD. A105

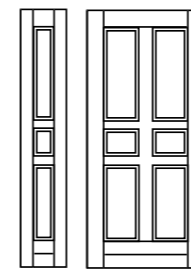

DIAMANTE MOD. A119

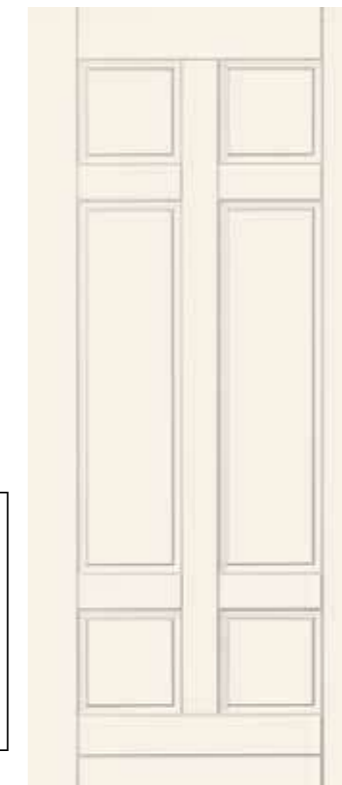
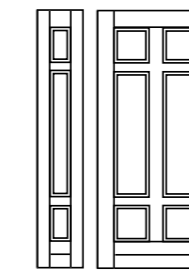

DIAMANTE MOD. A121

*LE FRESATURE
DEI MODELLI A111
- IN FUNZIONE
DELL'ALTEZZA
DELLE PORTE -
POSSONO ESSERE
INTERROTTE IN
CORRISPONDENZA
DEI FORI DELLA
MANIGLIA

*The milling of models
A111 according to the
height of the doors can be
interrupted at the holes
of the handles

*Les moulures des
models A111, en fonction
de la hauteur - peuvent
être coupées en
correspondance des trous
de la bequille

SKIPPER Collection



PANNELLI MULTISTRATO
COMPENSATO MARINO
O MDF IDROFUGO
SPESORE 15 MM

ENGRAVED MARINE PLYWOOD OR
WATERPROOF MDF PANELS
15 MM THICKNESS

PANNEAUX MULTICOUCHE
- CONTREPLAQUÉ OU MDF
HYDROFUGE ÉPAISSEUR 15 MM

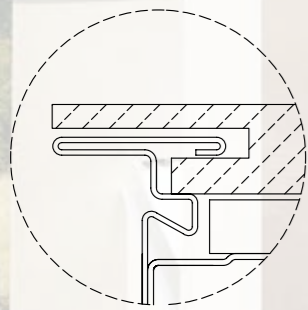
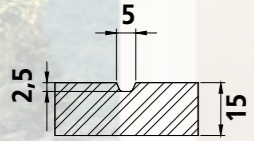

OPTIONAL:
PANNELLO INTERNO
AVVOLGENTE
A COPERTURA
DELLA CARENATURA

Optional: internal panel that
envelops and covers leaf pro
Option: panneau intérieur
enveloppant le carénage



SKIPPER MOD. A281

SKIPPER MOD. A282

SKIPPER MOD. A109

SKIPPER MOD. A285

LISCIO

A72

A74

A284

AL01

AL02

AL03

AL04

AL05

AL06

AL08

AL09

SKIPPER - DIAMANTE GLASS Collection



PANNELLI MULTISTRATO
COMPENSATO MARINO
O MDF IDROFUGO
SPESSORE 15 MM

ENGRAVED MARINE PLYWOOD OR
WATERPROOF MDF PANELS
15 MM THICKNESS

PANNEAUX MULTICOUCHE
- CONTREPLAQUÉ OU MDF
HYDROFUGE ÉPAISSEUR 15 MM

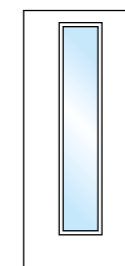

SKIPPER
GLASS
F206



SKIPPER GLASS

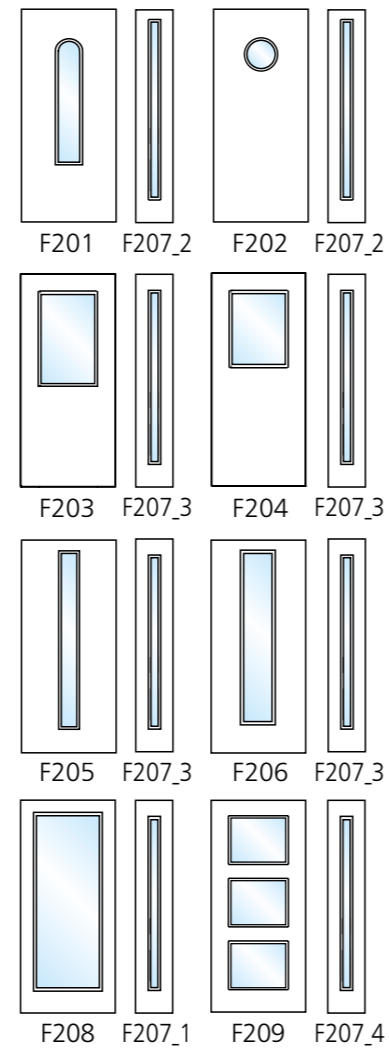

SKIPPER GLASS
MOD. F208
MAX FINESTRATURA



DIAMANTE GLASS

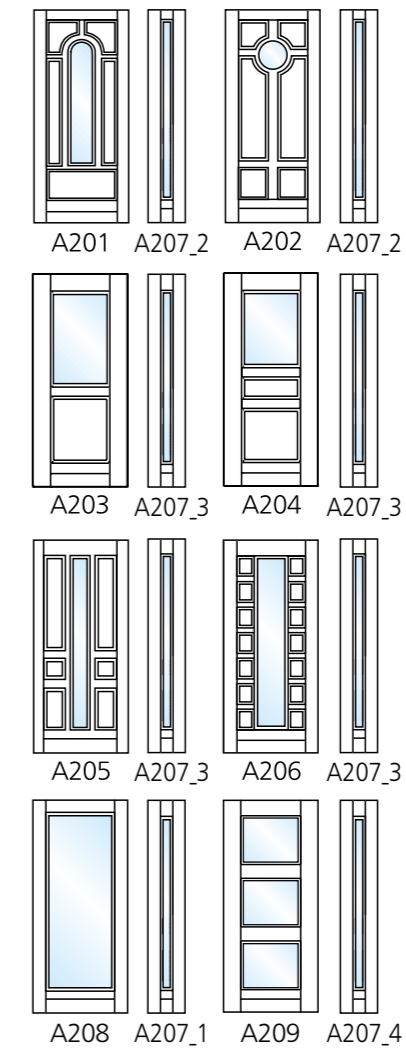

DIAMANTE GLASS
MOD. A206

VETROCAMERA SINGOLA

PROPRIETÀ TERMICHE:
1.1W/(m²k)

SINGLE GLAZING
THERMAL PROPERTIES
1.1W/(m²k)

DOUBLE VITRAGE
PROPRIETES
THERMIQUES:
1.1W/(m²k)

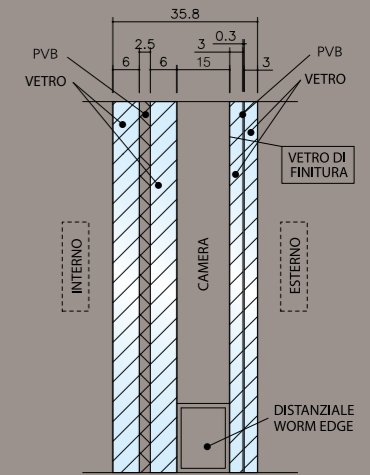

STANDARD PER ANTE FINESTRATE /SOPRALUCE/FISSI VETRATI

STANDARD
FOR WINDOWED
DOORS.
FIXED GLASS
TRANSOM.

STANDARD
POUR VITRAGE/
IMPOSTE/
PARTIES
FIXES LATERALES ET
SUPERIEURES

VETROCAMERA DOPPIA

PROPRIETÀ TERMICHE:
0.7W/(m²k)

DOUBLE GLAZING
THERMAL PROPERTIES
0,7W/(m²k)

TRIPLE VITRAGE
PROPRIETES
THERMIQUES:
0,7W/(m²k)

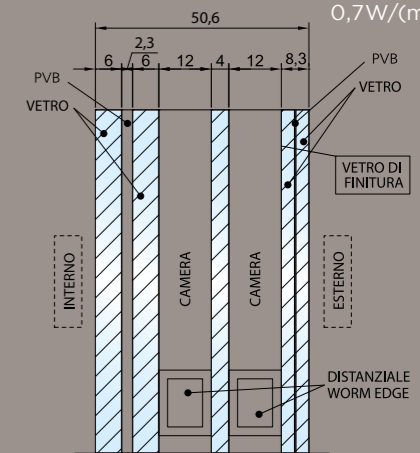

IN OPZIONE PER ANTE FINESTRATE

Stratobel 66.6 basso emissivo magnetronico -
12mm Argon 90% - 4mm Planibel clear -
12mm Argon 90% - Stratobel 33.1 trasparente

IN OPTION
FOR WINDOWED
DOORS

OPTION
POUR VITRAGE

FAST Collection



PANNELLO IN LEGNO
PANTOGRAFATO
SPESSORE 15 MM

WOOD PANTOGRAPHED PANEL
- FAST BASIC 15 MM THICKNESS.

PANNEAU EN BOIS PANTOGRAPHE
ÉPAISSEUR 15 MM

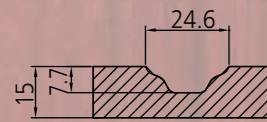

FAST MOD. A511

FAST MOD. A501



FAST MOD. A505

FAST MOD. A515



A518

A520

FAST MOD. A517

FAST MOD. A519



A508

A510

A506 A505

FAST MOD. A507

FAST MOD. A509



A522

A504

FAST MOD. A521

FAST MOD. A503



A514

A524

A516 A515

FAST MOD. A513

FAST MOD. A523

NAUTILUS Collection



PANNELLI IN ABS LACCATI
E SUPPORTATI CON
POLISTIRENE ESPANSO

LACQUERED ABS PANEL
SUPPORTED BY EXPANDED POLYSTYRENE

PANNEAUX EN ABS LAQUÉS ET
POLYSTYRÈNE EXPANSÉ

ABS

POLISTIRENE
POLYSTYRENE
POLYSTYRÈNE

RETRO
ABS

**DESIGN E MASSIMA
PERFORMANCE ISOLANTE.
CON IL RIVESTIMENTO
“NAUTILUS”
LA TRASMITTANZA
TERMICA SI ABBASSA FINO
A UN VALORE DI 1,0 W/m² K**

Design and top performance, “NAUTILUS”
panel grants a reduction of the thermic
transmittance till a value of 1,0 W/m² K

Design et performance isolante très élevée.
Grâce au revêtement “NAUTILUS”
la transmission thermique descend
jusqu’à une valeur de 1,0 W/m²K



LISCIO



B105



B106



B111



B112

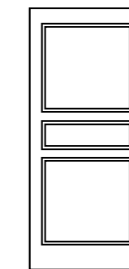

B113



B114

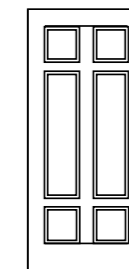

B121



B122

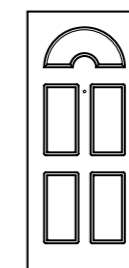

B511



B512

RENO Collection



PANNELLI PANTOGRAFATI
E RIVESTITI CON PELLICOLA PVC
SPESSORE 12 MM (16 MM CON
SPECCHIATURE)

PANTOGRAPHED PANELS COATED BY PVC
12 MM THICKNESS

PANNEAUX PANTOGRAPHÉS ET
RECOUVERTS D'UNE PELLICULE PVC
ÉPAISSEUR 12 MM

PELLICOLA PVC

HDF



RENO MOD. 138



RENO MOD. 012



RENO MOD. 05-070



RENO MOD. 035



RENO MOD. 016



RENO MOD. 057



RENO MOD. 076



RENO MOD. 085



RENO MOD. 090



RENO MOD. 091



RENO MOD. 097



RENO MOD. 105



RENO MOD. 183



RENO MOD. 185



RENO MOD. 173 SX



F436-3086
Sheffield Oak grey



F436-5014
Blattgruen



F436-5021
Tanngruen



F436-5036
Lichgrau



F436-5049
Silbergrau



F436-1012
Alux anthrazit



F436-1013
Alux silbergrau



F436-2001
Macoree



F436-2007
Montana Eiche tabak



F436-2022
Anegrè goldbraun

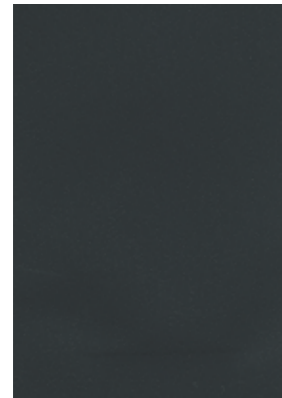

F436-6003
Anthrazitgrau SFTN matt



F436-5003
Anthrazitgrau

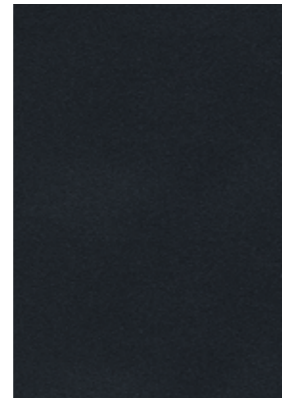

F436-6010
Schwarbraun SFTN matt



F436-6021
Tannengruen sftn matt



F436-6039
Silicia SFTN matt



F436-2035
Staufereiche terra



F436-2036
Staufereiche kolonial



F436-2060
Sipo



F436-3031
Birke rosè



F436-3041
Noce Sorrento natur



F436-6047
SFTN matt



F456-3081
Sheffield Oak light



F456-5057
Brillant weiss



F465-5015
Beige

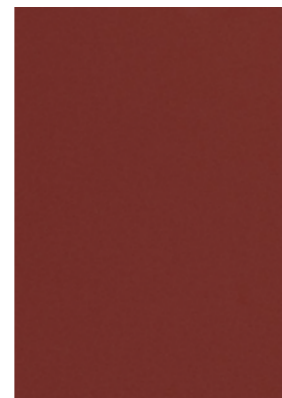

F436-5013
Rubinrot



F436-3042
Noce Sorrent balsamico



F436-3043
Cherry amaretto



F436-3058
Walnut amaretto



F436-3059
Walnuss terra



F436-3077
Newcastle Oak khaki

I COLORI E LE ESSENZE DEI PANNELLI RIPRODOTTI SU QUESTO CATALOGO SONO INDICATIVI E IN NESSUN MODO VINCOLANTI PER ALIAS.
The colors and the essence of the panels that have been reproduced in this catalogue are indicative and they are in no way an obligation for Alias.
Les couleurs et les essences des panneaux reproduites dans ce catalogue sont indicatives mais non contraignantes en ce qui concerne Alias

ETERN-ALL Collection



PANNELLI IN ALLUMINIO
VERNICIATI A FUOCO SUPPORTATI
CON MDF IDROFUGO

FIRE PAINTED ALLUMINIUM PANELS
WITH DAMPNESS PROOF MDF

PANNEAUX EN ALUMINIUM AU VERNI
INTUMESCENT AVEC MDF HYDROFUGE





PARIGI



ORLEANS



ANKARA



MALAGA



BIRMINGHAM



NIZZA



LUBLIN



TUAM



GRANADA



ANDORRA



DAMASCO



ISTANBUL



CRETA



BUCAREST



DRESDA



PORTO



INNSBRUCK



VIGO



FIRENZE



BORDEAUX



VALENCIA



LEEDS



ATENE



LISBONA



BERNA



AMSTERDAM



CADIZ



LIPSIA



CORDOBA



BILBAO



SYROS



COSTANZA



BRISTOL



STETTINO



RENA



TALLIN



MONTPELLIER



GOTEBORG



MELIDE



MALMO



TAMPERE



ALBONA



PATRASSO

PRIMA CLASSE Collection



PANNELLI
IN LEGNO MASSELLO
SPESSORE 20 MM

SOLID WOOD PANELS
20 MM THICKNESS

PANNEAUX EN BOIS MASSIF
ÉPAISSEUR 20 MM



PRIMA CLASSE MOD. A801
ROVERE MORDENZATO CASTAGNO
Chestnut stained oak
Chêne teinté châtaigner



PRIMA CLASSE MOD. A802
ROVERE NAT. LEGG. TINTO
Lightly stained natural oak
Chêne naturel teinté



PRIMA CLASSE MOD. A800
ROVERE MORDENZATO
Stained oak
Chêne teinté



PRIMA CLASSE MOD. A803
ROVERE TINTO MOKA
Moka stained oak
Chêne teinté moka



PRIMA CLASSE MOD. A804
OLMO MORDENZATO BIONDO
Blond stained elm
Orme teinté blond



PRIMA CLASSE MOD. A805
IROKO LEGG. TINTO
Lightly stained iroko
Iroko lèg. teinté



PRIMA CLASSE MOD. A806
IROKO LEGG. TINTO
Lightly stained iroko
Iroko lèg. teinté



PRIMA CLASSE MOD. A807
IROKO LEGG. TINTO
Lightly stained iroko
Iroko lèg. teinté



PRIMA CLASSE MOD. A808
CILIEGIO LEGG. TINTO
Lightly stained cherry
Cerisier lèg. teinté

| | PINO PINE PIN | C. WOOD | MOGANO MAHOGANY ACAJOU | ROVERE OAK CHÊNE | ROVERE SPAZ. OAK CHÊNE | CASTAGNO CHESTNUT CHÂTAIGNIER | CILIEGIO CHERRY CERISIER | IROKO | DOUGLAS |
|------|---------------------|---------|------------------------------|------------------------|------------------------------|-------------------------------------|--------------------------------|-------|---------|
| A800 | • | • | • | • | • | • | • | | |
| A801 | • | • | • | • | • | • | • | | |
| A802 | • | • | • | • | • | • | • | | |
| A803 | | • | • | • | • | • | • | • | |
| A804 | | | • | • | | • | • | • | |
| A805 | | | | | | | • | • | |
| A806 | | | • | • | | • | • | • | |
| A807 | | | • | • | | • | • | • | |
| A808 | | | • | • | | • | • | • | |
| A809 | | • | • | • | | • | • | • | |
| A810 | | | • | • | | • | • | • | |
| A811 | | • | • | • | | • | • | • | |
| A812 | • | • | • | • | | • | • | • | |



PRIMA CLASSE MOD. A809
IROKO LEGG. TINTO
Lightly stained iroko
Iroko lèg. teinté



PRIMA CLASSE MOD. A810
CILIEGIO LEGG. TINTO
Lightly stained cherry
Cerisier lèg. teinté



PRIMA CLASSE MOD. A811
CILIEGIO LEGG. TINTO
Lightly stained cherry
Cerisier lèg. teinté



PRIMA CLASSE MOD. A812
IROKO LEGG. TINTO
Lightly stained iroko
Iroko lèg. teinté

URBAN Collection



PANNELLI CON BUGNE
E CORNICI IN MASSELLO
APPLICATE
SPESSORE 15 MM

WOOD PANELS WITH APPLIED
SOLID WOODFRAMES AND
ASHLARS 15 MM THICKNESS

PANNEAUX EN BOIS AVEC
MOELLONS ET ENCADREMENTS
EN BOIS MASSIF APPLIQUÉS
ÉPAISSEUR 15 MM

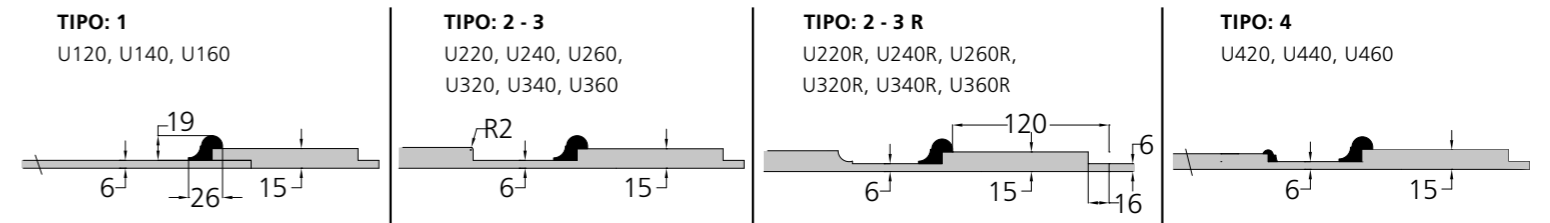
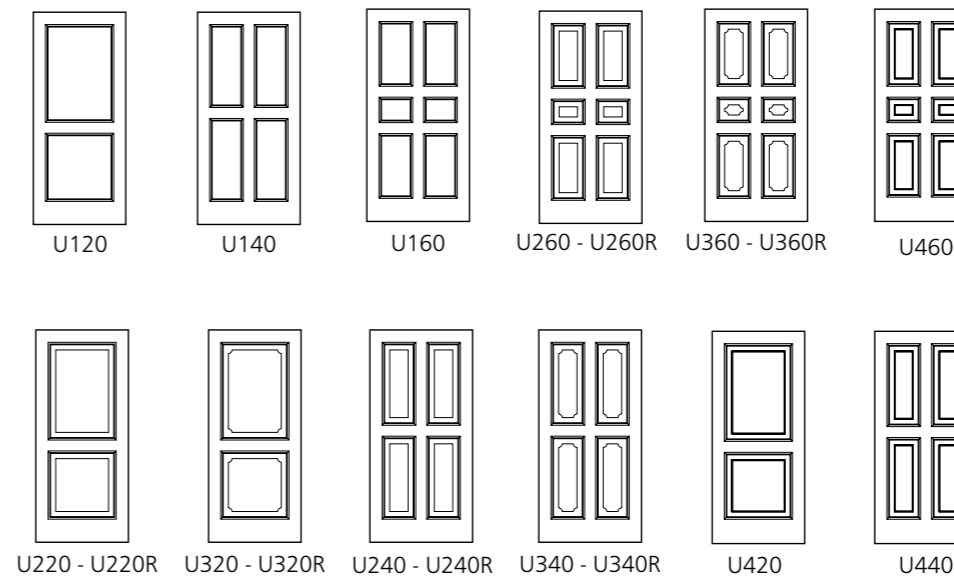

CORNICI APPLICATE NEL RISPETTO
DELLA TRADIZIONE ARTIGIANALE.

Applied mouldings according
to the handicraft tradition.
Encadrement appliqué selon
la tradition artisanale



CILIEGIO
Cherry
Cerisier



MOGANO
Mahogany
Acajou



TANGANICA
Tanganyika
Tanganica



ROVERE
Oak
Chêne

NATUR-ALL Collection



PANNELLI IN ALLUMINIO
SPESSORE 6 MM

ALUMINIUM PANELS
6 MM THICKNESS

PANNEAUX EN ALUMINIUM
ÉPAISSEUR 6 MM

A61



ALLUMINIO LISCIO
Flat aluminium
Aluminium lisse

A63

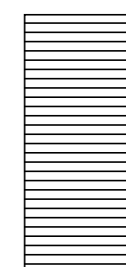

ALLUMINIO RIGATO ORIZZONTALE
Horizontal striped aluminium
Aluminium à rayures horizontales



INTARSIO Collection



PANNELLI IMPIALLACCIATI
SPESSORE 6 MM

FLAT CHIPBOARD PANELS
6 MM THICKNESS

PANNEAUX PLAQUÉS
ÉPAISSEUR 6 MM

A51

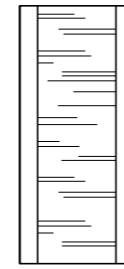

NOCE NAZIONALE
Italian walnut
Noyer national

TANGANICA MEDIO
Medium tanganyika
Tanganica moyen

TANGANICA CHIARO
Light tanganyika
Tanganica clair

A52

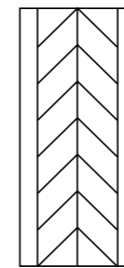

A53

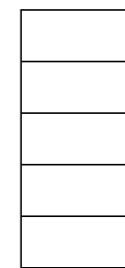

NOCE NAZIONALE
Italian walnut
Noyer national

TANGANICA MEDIO
Medium tanganyika
Tanganica moyen

TANGANICA CHIARO
Light tanganyika
Tanganica clair

TANGANICA NATURALE
Natural tanganyika
Tanganica naturel

A54

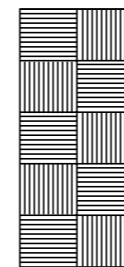

A55

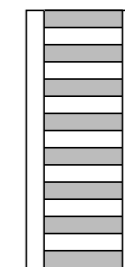

ROVERE WENGÉ
Wengé oak
Chêne wengé

ROVERE SBIANCATO
Bleached oak
Chêne blanc

ROVERE WENGÉ
Wengé oak
Chêne wengé

BASIC LINE Collection



ALIAS

INSERTO IN ALLUMINIO

ALUMINUM INSERT
INSERT ALUMINUM

ALTRE CONFIGURAZIONI
DISPONIBILI SU RICHIESTA.

Others configurations
available upon request.
Autres configurations
disponibles sur demande

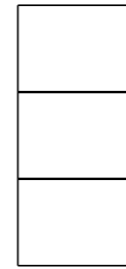

INSERTO 2



INSERTO 3

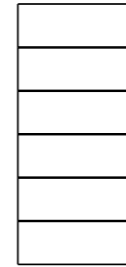

INSERTO 5



INSERTO 6

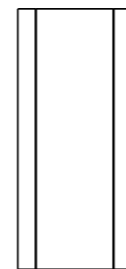

INSERTO 7

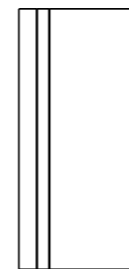

INSERTO 9

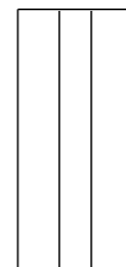

INSERTO 11

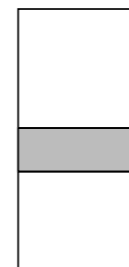

PAIS
LIGHT

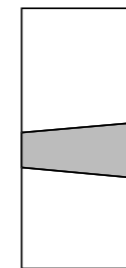

CARGO
LIGHT

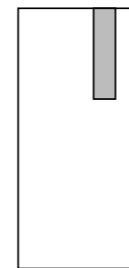

LINEA
LIGHT



SU PANNELLO
LAMINATO
TRANCHÉ
CENERE

on ash tranché
laminated
wood panel

sur panneau
mélaminé
tranché cendre

SU PANNELLO
MATRIX
ROVERE GRIGIO

on matrix grey
oak laminated
wood panel

sur panneau
Matrix chêne gris



SU PANNELLO
IN MDF
RAL 9010

on laquered
MDF panel RAL 9010

sur panneau en
MDF RAL 9010

SU PANNELLO
IN METACRILATO
ROSSO LUCIDO

on methacrylate
laquered red panel

sur panneau en
méthacrylate
rouge laqué

BASIC Collection



PANNELLI IMPIALLACCIATI
SPESSORE 6 MM

FLAT CHIPBOARD PANELS
6 MM THICKNESS

PANNEAUX PLAQUÉS
ÉPAISSEUR 6 MM



TANGANICA CHIARO - 1
Light tanganyika
Tanganica clair



TANGANICA MEDIO - 2
Medium tanganyika
Tanganica moyen



TANGANICA SCURO - 3
Dark tanganyika
Tanganica foncé



CILIEGIO MEDIO - 4
Cherry
Cerisier moyen



TANGANICA CILIEGIATO - 5
Cherry tanganyika
Tanganica cerisier

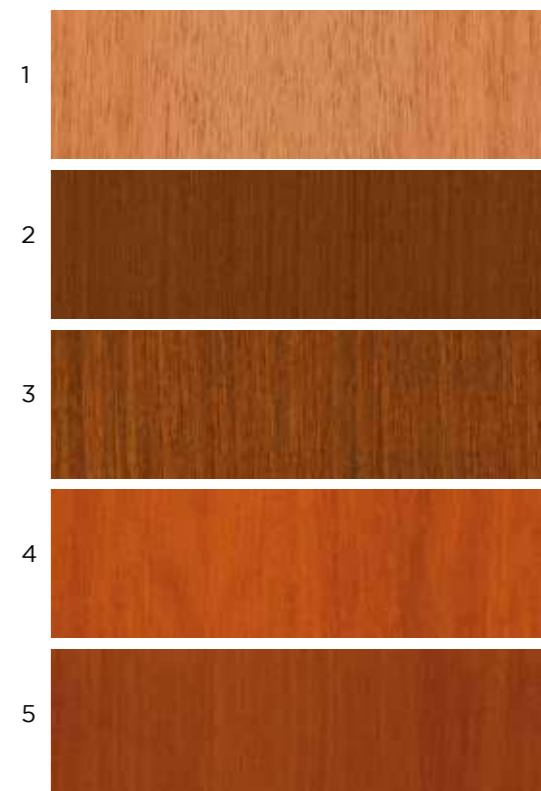



MOGANO CHIARO - 6
Light mahogany
Acajou clair



MOGANO MEDIO - 7
Medium mahogany
Acajou moyen



MOGANO SCURO - 8
Dark mahogany
Acajou foncé



ROVERE GRIGIO
ORIZZONTALE P - 11
Grey horizontal oak P
Chêne gris à veinures horizontales P



ROVERE SBIANCATO
ORIZZONTALE P - 12
Bleached horizontal oak P
Chêne blanc à veinures horizontales P

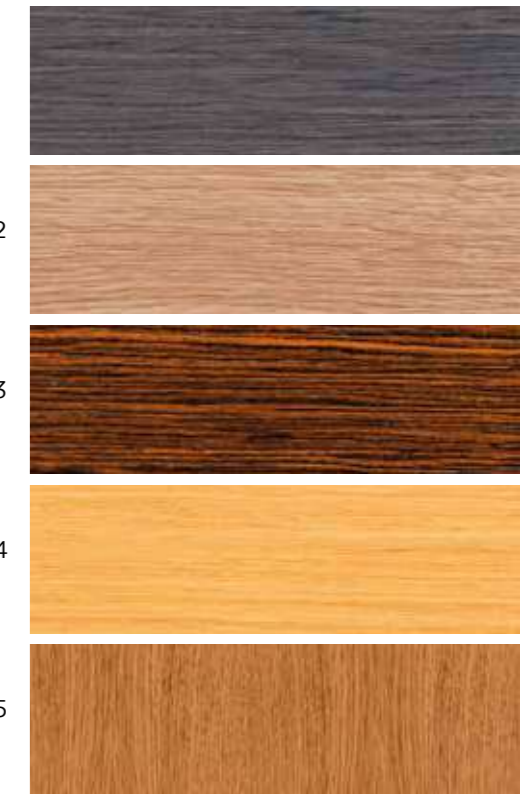

11
12
13
14
15



6
7
8
9
10



CASTAGNO - 9
Chestnut
Châtaignier



NOCE NAZIONALE - 10
Italian walnut
Noyer national



ROVERE WENGÉ
ORIZZONTALE P - 13
Wengé horizontal oak P
Chêne wengé à veinures horizontales P



ROVERE MIELATO
ORIZZONTALE P - 14
Honey horizontal oak P
Chêne miel à veinures horizontales p



ROVERE MIELATO
VERTICALE - 15
Honey vertical oak p
Chêne miel à veinures verticales p

BASIC Collection



PANNELLI LAMINATINI
SPESSORE 6 MM

LAMINATED WOOD PANELS
6 MM THICKNESS

PANNEAUX MÉLAMINÉS
ÉPAISSEUR 6 MM



ALIAS



ROVERE WENGÉ L
ORIZZONTALE - 1
Wengé oak L
Chêne wengé L à veinures horizontales



ROVERE SBIANCATO L
ORIZZONTALE - 2
Bleached oak L
Chêne blanc L à veinures horizontales



TANGANICA CHIARO L - 3
Light tanganyika L
Tanganica clair L



TANGANICA BRUNO L - 4
Dark tanganyika L
Tanganica foncé L



NOCE BIONDO C - 5
Blonde walnut C
Noyer blond C

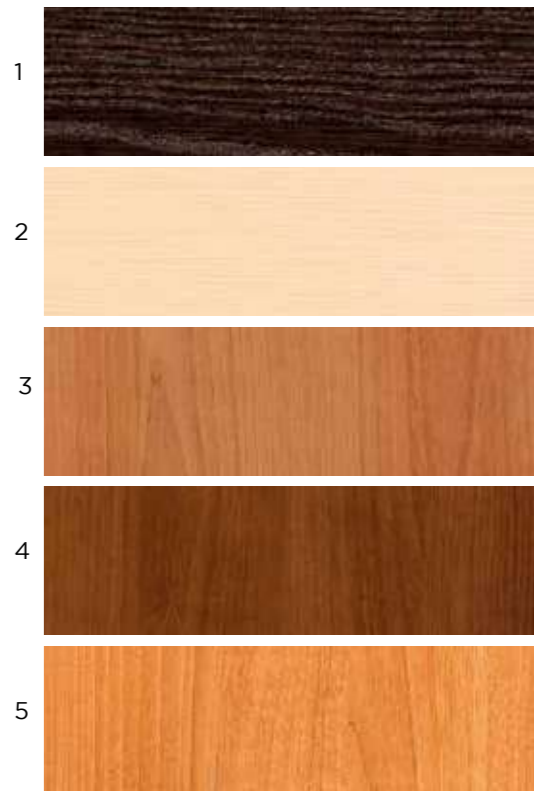



6

7

8

9



NOCE NAZIONALE C - 6
Italian walnut C / Noyer national C



FAGGIO L - 7
Beech L / Hêtre L



CILIEGIO C - 8
Cherry C / Cerisier C



ROVERE L - 9
Oak L / Chêne L



RAL 9016



RAL 9010



BIANCO CARENA



RAL 1013

RAL 9016

RAL 9010

BIANCO CARENA

RAL 1013

BASIC Collection



PANNELLI LAMINATI MATRIX
SPESSORE 6 MM

MATRIX LAMINATED WOOD PANELS
6 MM THICKNESS

PANNEAUX MÉLAMINÉS MATRIX
ÉPAISSEUR 6 MM

ALIAS



MATRIX BIANCO - 1
Matrix white / Matrix blanc



MATRIX MARBELLA - 2
Matrix marbella / Matrix Marbella



MATRIX ROVERE GRIGIO - 3
Matrix grey oak / Matrix chêne gris



MATRIX PALISSANDRO - 4
Matrix rose oak / Matrix palissandre



MATRIX LARICE - 5
Matrix larch / Matrix mélèze



MATRIX NERO - 6
Matrix noire / Matrix black

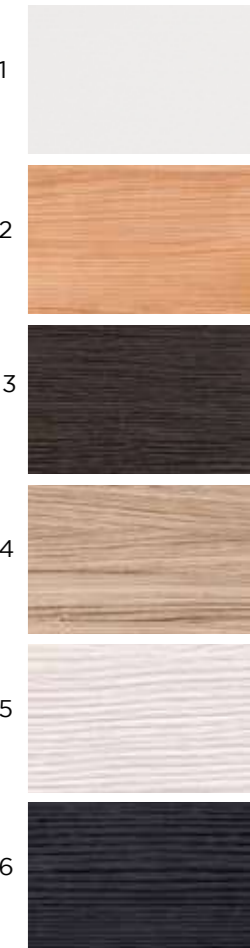

BASIC Collection



PANNELLI LAMINATI TRANCHÉ
SPESSORE 6 MM

TRANCHÉ LAMINATED WOOD PANELS
6 MM THICKNESS

PANNEAUX MÉLAMINÉS TRANCHÉ
ÉPAISSEUR 6 MM



ALIAS



CENERE - 1
Ash / Cendre



CAFFÈ - 2
Cafè / Café



TERRA - 3
Earth / Terre



SABBIA - 4
Sand / Sable



BASIC FASTONE Collection



PANNELLI COSTITUITI
DA UNA LASTRA DI
VERA ROCCIA NATURALE
SUPPORTATA DA UNO
STRATO DI RESINA

NATURAL ROCK PANELS SUPPORTED
BY A LAYER OF RESIN

PANNEAUX COMPOSÉS PAR UNE
PLAQUE DE ROCHE AVEC UNE
COUCHE DE RÉSINE



Modello
"FACESTONE"
ARDESIA



Modello
"FACESTONE"
VULCANO

BASIC Collection



PANNELLI MDF LACCATI
LUCIDO/OPACHI
SPESSORE 6 MM

LAQUERED MDF PANELS AVAILABLE
WITH OPAQUE OR BRILLIANT FINISHING
6 MM THICKNESS

PANNEAUX MDF LAQUÉS
SATINÉS ÉPAISSEUR 6 MM



ALIAS



LACCATO ROSSO
Red lacquered
Rouge laqué



“FLAT Collection”

UN SISTEMA NATO PER RENDERE UNICO IL TUO AMBIENTE. CON LA COLLEZIONE FLAT, LO SPAZIO CONQUISTA UNA NUOVA ELEGANTE DIMENSIONE. NELLA PARTE INTERNA DELLA PORTA, TELAIO E CARENA SPARISCONO, LASCIANDO IL POSTO AD UNA SUPERFICIE SENZA SOLUZIONE DI CONTINUITÀ, LISCIA E COMPLANARE A SÉ STESSA. UN MODELLO DISPONIBILE PER LE STRUTTURE SILVER, GOLD, PLATINUM E TITANIUM, DALLA MASSIMA PERFORMANCE ISOLANTE.

A system created to make your home unique. With Flat collection, spaces obtain a new, elegant dimension. In the internal side of the door, frame and perimetral profile disappear, leaving space to a continuous, smooth and Flat to wall surface. Flat is a model available for Silver, Gold, Platinum and Titanium structures with the best insulating performances.

Un système né pour personnaliser votre milieu. Grâce à la ligne Flat, l'espace prend une dimension nouvelle et élégante. Le bâti et le carénage disparaissent dans la partie intérieure de la porte laissant place à une surface lisse et continue. Modèle disponible pour les structures Silver, Gold, Platinum et Titanium, de très haute performance isolante.

FLAT



IN ROVERE ORIZZONTALE TINTO MIELE.
MANIGLIA FENIX A ROSETTA QUADRATA IN
CROMO SATINATO.

FLAT IN HORIZONTAL HONEY OAK. FENIX
HANDLE WITH MATT CHROME SQUARED
SUPPORT.

FLAT EN CHÊNE MIEL À VEINURES VERTICALES.
POIGNÉE FENIX AVEC ROSACE CARRÉE EN
CHROMÉ SATINÉ.

FLAT TABULA - RIGO



LACCATO OPACO RAL 7036. MANIGLIA H4 A
ROSETTA QUADRATA IN CROMO SATINATO.

TABULA-RIGO FLAT LAQUERED RAL 7036. H4
HANDLE WITH MATT CHROME SQUARED
SUPPORT.

FLAT TABULA -RIGO SATINÉ RAL 7036. POIGNÉE
H4 AVEC ROSACE CARRÉE EN CHROMÉ SATINÉ.



FLAT TABULA - GEO



LACCATO RAL 7044. MANIGLIA H4 A
ROSETTA QUADRATA IN CROMO SATINATO.

TABULA-GEO FLAT LAQUERED RAL 7044. H4
HANDLE WITH MATT CHROME SQUARED
SUPPORT.

FLAT TABULA -GÈO. RAL 7044. POIGNÉE H4
AVEC ROSACE CARRÉE EN CHROMÉ SATINÉ.

FLAT INFINITY



LAMINATO TRANCHÉ COLOR TERRA.
MANIGLIA FENIX A ROSETTA QUADRATA IN
CROMO SATINATO.

LAMINATED EARTH TRANCHÉ. FENIX HANDLE
WITH MATT CHROME SQUARED SUPPORT.

MÉLAMINÉ TRANCHÉ TERRE. POIGNÉE FENIX
AVEC ROSACE CARRÉE EN CHROMÉ SATINÉ.





LA BLINDATA RASOMURO
SELEZIONATA AL COMPASSO D'ORO



ALIAS

SHOWROOM

Una rete capillare di retailer selezionati su tutto il territorio nazionale e nei principali paesi europei, è a tua disposizione per guidarti nella scelta della tua Design Security Doors Alias. Un team composto da professionisti costantemente aggiornati è in grado di offrirti un servizio affidabile fatto su misura per te, per rispondere a ogni tua esigenza.

Per l'interno degli spazi espositivi dei rivenditori, Alias studia il posizionamento del campionario attraverso pop-up esperienziali dall'immagine fortemente rappresentativa del brand in cui è possibile completare l'esperienza di acquisto.



Un réseau étendu de retailer sur tout le territoire national et dans les principaux pays européens est à votre service pour vous conduire dans le choix de votre Design Security Door Alias. Une équipe d'experts constamment à la dernière information est capable d'offrir un service fiable sur mesure, pour répondre à vos besoins. Pour l'intérieur des espaces d'exposition des distributeurs, Alias prévoit la disposition du témoin à travers de pop-up d'expertise avec image fortement représentative de la marque, dans laquelle il est possible d'achever l'achat.

A capillary network of selected retailers throughout the national territory and in the main European countries, is at your disposal to guide you in choosing your Design Security Doors Alias. A team of constantly updated professionals is able to offer you a reliable service tailored to you, to meet all your needs. For the interiors of the exhibition spaces of retailers, Alias studies the positioning of the sample through experiential pop-ups with a strongly representative image of the brand, in which it is possible to complete the shopping experience.



Since 17 years Alias has been a leading company in the sector of entrance doors with safety, burglar-proof and design features. He has participated in all the editions of the MADE EXPO, the milanese event, during which all the news and new collections are previewed. The company, based in Piacenza, designs, manufactures and markets in Italy and in over 30 countries abroad innovative products for technological performances and aesthetic contents. The Alias entry doors are subjected to continuous and accurate checks in production, and to tests by prestigious Italian and foreign certification agencies, as far as the resistance to burglary and thermal and acoustic insulation are concerned. Alias participates intensively in the work of drafting European standards, contributes to their spread, knowledge and correct application also as a member of the group of producers of entry doors of the association Legnoarredo of Federlegno. The entrance doors and the Alias security elements are made of environmentally friendly and totally recyclable materials.

Da 17 anni Alias è protagonista di primo piano nel settore delle porte di ingresso a caratteristica di sicurezza antieffrazione e di design.

Ha partecipato a tutte le edizioni di Made Expo, la kermesse milanese in occasione della quale vengono presentate in anteprima tutte le novità e le nuove collezioni.

L'azienda, che ha sede a Piacenza, progetta, produce e commercializza in Italia e in oltre 30 paesi all'estero prodotti innovativi per contenuti tecnologici, prestazionali ed estetici.

Le porte d'ingresso Alias sono sottoposte a continui e accurati controlli in produzione e a test da parte di prestigiosi enti di certificazione italiani e stranieri per le prestazioni di resistenza all'effrazione e di isolamento termico e acustico.

Alias partecipa intensamente ai lavori di elaborazione delle norme europee, contribuisce alla loro diffusione, conoscenza e corretta applicazione, anche in qualità di membro del gruppo produttori porte di ingresso dell'associazione Legnoarredo di Federlegno.

Le porte di ingresso e gli elementi di sicurezza Alias sono realizzati in materiali ecosostenibili e totalmente riciclabili.

Depuis 17 ans Alias joue un rôle principal dans le secteur des portes d'entrée, de sécurité et de design. Elle a participé à toutes les éditions de Made Expo, la kermesse milanaise lors de laquelle sont présentées en avance toutes les nouveautés et les nouvelles collections. L'entreprise, qui a son siège à Piacenza, conçoit, produit et commercialise en Italie et dans plus de 30 pays à l'étranger produits innovants du point de vue technologique, de performance et esthétique. Les portes d'entrée Alias sont soumises à contrôles continus et minutieux et à test par des prestigieux organismes de certification italiens et étrangers pour les prestations de résistance à l'effraction et d'isolement thermique et acoustique. Alias prend une part active aux travaux d'élaboration des normes européennes, contribue à leur diffusion, connaissance et bonne application, aussi en tant que membre du group des producteurs de portes d'entrée de l'association Legnoarredo de Federlegno. Les portes d'entrée et les éléments de Sécurité Alias sont réalisés avec matériaux écologiquement durables et complètement recyclables.



223.4/225° X: -27.25
199.3/200° Y: 0.00
70.0/70° Z: 0.00
Hu1: 100% E: 0.00H
Buf: 0 SD
Stampa... 2.4%

SISTEMI DI
STRUTTURA

STRUCTURES SYSTEM
STRUCTURES

ALIAS PRODUCE DA OLTRE 17 ANNI PORTE BLINDATE DAGLI ELEVATI STANDARD QUALITATIVI, SIA DAL PUNTO DI VISTA TECNOLOGICO CHE PRESTAZIONALE ED ESTETICO.

Tutte le strutture ALIAS, di serie, sono dotate di:

Defender ANTITRAPANO E ANTISTRAPPO

ANTI-DRILL
CYLINDER
PROTECTION
PROTECTEUR
ANTI-PERCAGE



Cilindri ANTI BUMPING

ANTI-BUMP CYLINDERS
CYLINDRES RESISTANTS
AU BUMPING

3 GUARNIZIONI

THREE GASKETS
TROIS JOINTS

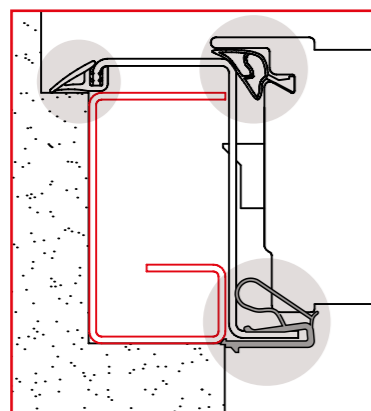

Terminale LIGHT STOP

LIGHT STOP SYSTEM
SISTEME LIGHT STOP



It's more than 17 years since Alias began to produce high quality security doors both in terms of technology and performance and aesthetic. All the Alias structures have this standard equipment:

Alias produit depuis plus de 17 ans portes blindées très hautes de gamme, tant pour l'aspect esthétique que pour celui technologique. Chaque structure Alias a de base:

NUOVO REGISTRO CHE PERMETTE DI SOSTENERE L'ANTA QUANDO SI ALLENTANO I FISSAGGI FRONTALI (A)

NEW REGISTERING LATCH THAT ALLOWS TO SUPPORT THE DOOR WHEN LOOSENING THE FRONTAL FASTENERS (A)
NOUVEAU RÉGLAGE QUI PERMET DE DÉPLACER MÉCANIQUEMENT LA VANTAIL LORSQU'ON DESERRER LA PARTIE (A) DE LA PAUMELLE (AU LIEU DE MANUELLEMENT)

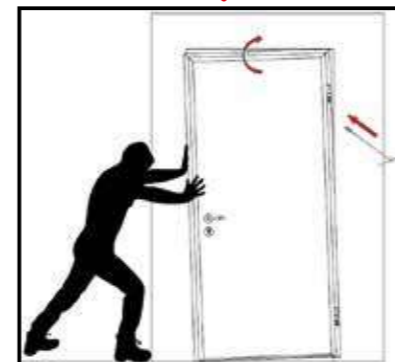

B

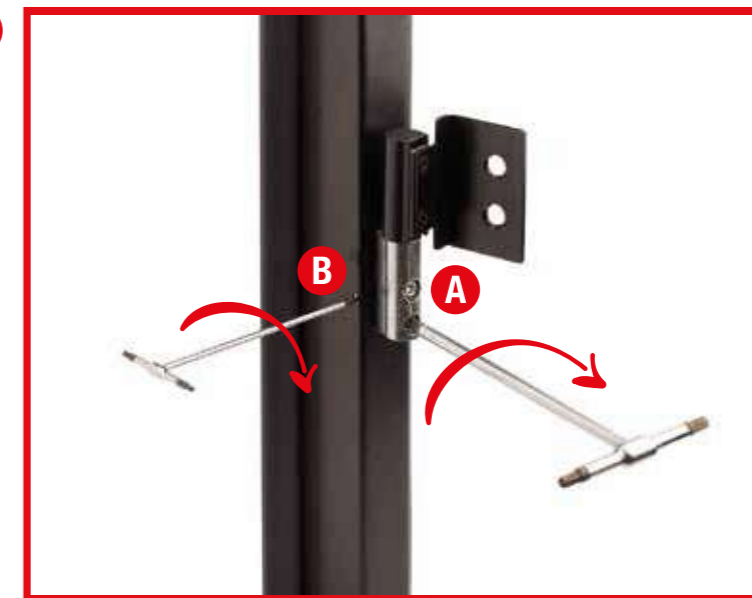

A

REGOLAZIONE IN LARGHEZZA DELLE PORTE

DOOR WIDTH
ADJUSTMENT
MODALITÉS DU
RÉGLAGE DE LA
POSITION EN LARGEUR
DU VANTAIL: D'ABORD
DESSERRER (A) PUIS
DÉPLACEMENT DE
LA PAUMELLE PAR (B)
PUIS RESSERRER (A)

Copri Cerniere TAPPINI VITI

COVER HINGES
CACHE-PAUMELLES

COVER SCREWS
CACHE-VIS

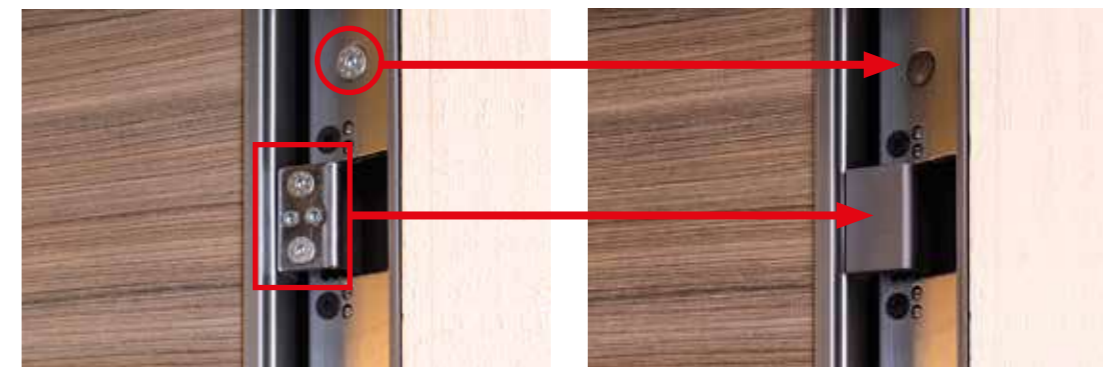

PER UNA RESA ESTETICA MIGLIORE, TELAIO E CARENA
FINITURA ALLUMINIO SONO SEMPRE ABBINATI A GUARNIZIONI
- sia di battuta dell'anta che di battuta esterna del telaio - **DI COLORE GRIGIO**



To ensure a better aesthetic, aluminum frame and perimetral profile are always provided with internal and external grey gaskets

Pour améliorer l'esthétique la huisserie aluminium est toujours associée aux joints couleur alu.

Maniglieria DI SERIE

STANDARD HANDLES - POIGNÉES STANDARD

ALLUMINIO BRONZATO
bronze aluminium
aluminium bronzé



ARGENTO
silver
argent



Maniglieria OPTIONAL

OPTIONAL HANDLES - POIGNÉES EN OPTION

OTTONE LUCIDO
bright brass
brass poli



CROMO LUCIDO
bright chrome
chromé poli



CROMO SATINATO
matt chrome
chromé satiné



Maniglieria OPTIONAL

OPTIONAL HANDLES - POIGNÉES EN OPTION



FENIX
CROMO SATINATO
matt chrome
chromé satiné



H4
CROMO SATINATO
matt chrome
chromé satiné



H4
BIANCO OPACO
matt white
blanc mat
RAL 9010



H4
NERO OPACO
matt black
noire mat
RAL 9005



H4
GRIGIO GRAFITE
graphite grey
gris graphite

CROMO SATINATO
matt chrome
chromé satiné

116 cm



46 cm

Maniglioni

OTTONE LUCIDO
bright brass
brass poli



28 cm

OTTONE SATINATO
matt brass
brass satiné

CROMO LUCIDO
bright chrome
chromé poli

CROMO SATINATO
matt chrome
chromé satiné



Porte blindate a taglio termico cerniere a vista “Steel” o a scomparsa “Silver”

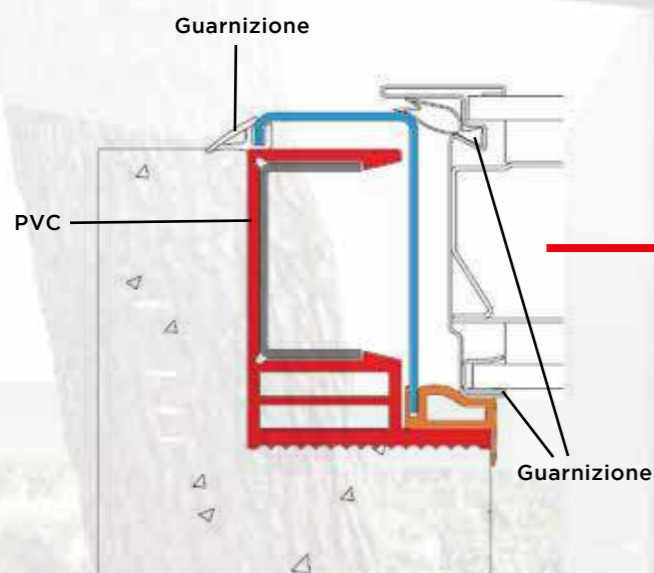

“ISOLA”

- Telaio e controtelaio a taglio termico
- Trasmittanza termica - 1,0 W/m² K
- Abbattimento acustico - 40 dB
- CLASSE 3 DI ANTIEFFRAZIONE UNI-EN 1627

“THERMAL”

- **Aerogel**
- Telaio e controtelaio a taglio termico
- Trasmittanza termica - 0,8 W/m² K
- Abbattimento acustico - 40 dB
- CLASSE 3 DI ANTIEFFRAZIONE UNI-EN 1627

Armored thermal break doors “Steel” with visible hinges or “Silver” with hidden hinges.

Portes blindées a coupe thermique avec charnières externes “Steel” ou invisibles “Silver”



L’isolamento termico di un’abitazione, perchè possa raggiungere le più alte performance, non può non tenere conto dei cosiddetti “ponti termici” che si creano sulle porte blindate d’ingresso in prossimità dei materiali a profilo continuo.

I materiali metallici con cui è costruita una porta, se da un lato risultano necessari per le prestazioni anti-effrazione, dall’altro favoriscono **il flusso di energia** dalla temperatura maggiore a quella minore con conseguente formazione di **condensa** – visibile solitamente sul telaio e, nei casi peggiori, anche di **muffe**.

Per questo il dipartimento di Ricerca&Sviluppo Alias ha progettato una nuova generazione di porte blindate totalmente a taglio termico, **senza intaccare il design della porta e mantenendo i medesimi ingombri**.

The thermal insulation of a house that it can reach the highest performances can not take into account the so-called “thermal bridges” that are created on the armored entrance doors near the continuous profile materials

The metal materials with which the door is built, if on the one hand are necessary for anti-burglary performance, on the other hand the flow of energy from the higher to the lower temperature with the consequent formation of condensation, usually visible on the frame and worst cases, even mildew.

This is why the Alias research and development department has projected a new generation of fully thermal break armored door. Without affecting the design of the door and keeping the same dimensions.

L’isolation thermique d’une maison, pour atteindre les hautes performances, doit considérer ce que l’on défine “ponts thermiques” que vont se créer sur les portes (blindées) d’entrée près de matériaux a profil continu

Les matériaux métalliques que forment une porte, si d’un côté sont nécessaires pour les performances de l’autre côté aident le flux d’énergie de la température plus élevée auquelle plus basse avec formation de condensé, visible généralement sur le cadre de la porte et, dans les pires cas, de moules aussi.

Pour cela le département de recherche&développement Alias a concu une nouvelle génération de portes blindées totalement à coupe thermique, sans affecter la conception de la porte et garder les memes dimensions.

NOVITÀ

COMPATIBILE CON IL MODELLO FLAT

THERMAL SILVER

CLASSE 3 di antieffrazione UNI-EN 1627
Anti Burglary - Résistance à l'effraction

TRASMITTANZA TERMICA - 0,8 W/(m².K)
Thermic conduction - Transmission thermique

ABBATTIMENTO ACUSTICO - 40 dB
Acoustic performance - Affaiblissement acoustique

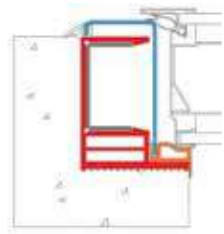

STRUTTURA COMPOSTA DA 1 FOGLIO + 5 OMEGA DI RINFORZO TUTTO IN LAMIERA ZINCATA
Galvanized steel frame made by 1 sheet metal + 5 reinforcements galvanized steel
Structure composée d'1 feuille + 5 oméga de renfort le tout en tôle galvanisée

SPIONCINO GRANDANGOLARE
Spyhole
Cilleton quadrangulaire

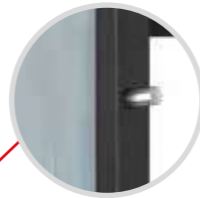

CHIAVISTELLO SUPERIORE IN ACCIAIO DIAM. 18 mm
Steel Top bolt 18 mm thickness
Pêne haut en acier diam 18 mm

N°6 ROSTRI FISSI SUL LATO CERNIERE IN ACCIAIO
6 Fixed Steel bolts hinges side
6 pènes fixes du côté paumelle en acier



TELAIO IN LAMIERA PREFILMATA CON PVC
Sheet metal inner frame PVC coated
Châssis en tôle protégé par pellicule PVC

CARENATURA PERIMETRALE IN LAMIERA PREFILMATA CON PVC
Sheet metal Perimetral profile PVC coated
Carénage de périmètre en tôle protégé par pellicule PVC

GRUPPO SERRATURA
Lock group
Groupe serrure



POZZETTI IN PVC SIA SUL LATO SERRATURA CHE SUL LATO CERNIERA
PVC pit lock side and hinges side
Puits en pvc côté serrure et côté paumelle



INCONTROSCROCCO AUTOREGISTRANTE
Self Registering latch
Verrou enregistrement automatique



CHIAVISTELLO INFERIORE IN ACCIAIO DIAMETRO 18 mm
Steel bottom bolt 18 mm thickness
Pêne bas en acier diam 18 mm

PARASPIFFERI INFERIORE REGISTRABILE + SPUGNA POLIURETANICA PER L'ABBATTIMENTO ACUSTICO
Bottom Movable Sill + polyurethane material for acoustic insulation
Revêtements intérieur et extérieur lisses épaisseur 6 mm

RIVESTIMENTO INTERNO ED ESTERNO LISCIO SP. 6 mm
Finishing flat internal and external panel 6 mm thickness
Revêtements intérieur et extérieur lisses épaisseur 6 mm

PANNELLO IN POLISTIRENE ALTA DENSITÀ INTERNO
High density Polystyrene internal panel
Panneaux en polystyrène intérieurs de haute densité

AEROGEL

CERNIERE A SCOMPARSA



CERNIERA A SCOMPARSA REGISTRABILE SU 2 ASSI
2 axis External invisible adjustable hinges
Paumelle encastré enregisttable sur 2 axes



VERSIONI

Versions
Versiones

Thermal Silver R



DOPPIA MAPPA NON RICIFRABILE (CAMBIO FACILE CISA)
Non recordable Double bit
Double bit non ré-chiffirable

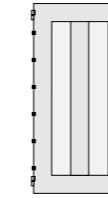

Thermal Silver RS



GRUPPO DI CHIUSURA DI SICUREZZA A DOPPIA MAPPA RICIFRABILE
Recordable Double bit
Groupe de fermeture de sécurité à double bit ré-chiffirable

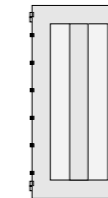

Thermal Silver C



CILINDRO EUROPEO
European Cylinder profile
Cylindre européen

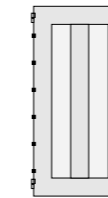

Thermal Silver CS



DOPPIO CILINDRO EUROPEO CON BLOCCO
Double European Cylinder profile with security lock
Double cylindre européen avec blocage

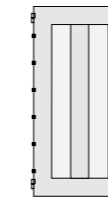

MISURE STANDARD

Standard Measures
Mesures standard

Larghezza / Width / Largeur:
cm 80 - 85 - 90

Altezza / Height / Hauteur:
cm 210

FUORI MISURA REALIZZABILI

Possible out of standard
Hors mesures réalisables

Larghezza / Width / Largeur :
da cm 50 a cm 110
from 50 cm to 110 cm
largeur de cm 50 à cm 110

Altezza / Height / Hauteur:
da cm 180 a cm 250
from 180 cm to 250 cm
hauteur de cm 180 à cm 250

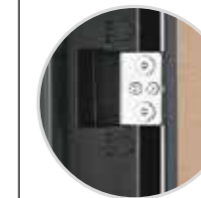

SISTEMA BREVETTATO

Registered patented system
Système breveté

CERNIERA A SCOMPARSA ABSOLUTE
ABSOLUTE invisible hinge
Paumelle encastré Absolute

NOVITA

THERMAL STEEL

CLASSE 3 di antieffrazione UNI-EN 1627
Anti Burglary - Résistance à l'effraction

TRASMITTANZA TERMICA - 0,8 W/(m².K)
Thermic conduction - Transmission thermique

ABBATTIMENTO ACUSTICO - 40 dB
Acoustic performance - Affaiblissement acoustique

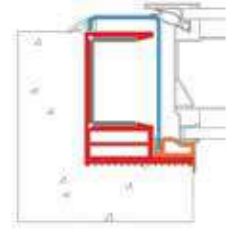

STRUTTURA COMPOSTA DA 1 FOGLIO + 5 OMEGA DI RINFORZO TUTTO IN LAMIERA ZINCATA
Galvanized steel frame made by 1 sheet metal + 5 reinforcements galvanized steel
Structure composée d'1 feuille + 5 oméga de renfort le tout en tôle galvanisée

N°6 ROSTRI FISSI SUL LATO CERNIERE IN ACCIAIO
6 Fixed Steel bolts hinges side
6 pènes fixes du côté paumelle en acier



CERNIERA A VISTA REGISTRABILE SU 2 ASSI
2 axis External adjustable hinges
Paumelle appliquée enregistrable sur 2 axes



PARASPIFFERI INFERIORE REGISTRABILE + SPUGNA POLIURETANICA PER L'ABBATTIMENTO ACUSTICO
Bottom Movable Sill + polyurethane material for acoustic insulation
Revêtements intérieur et extérieur lisses épaisseur 6 mm

RIVESTIMENTO INTERNO ED ESTERNO LISCIO SP. 6 mm
Finishing flat internal and external panel 6 mm thickness
Revêtements intérieur et extérieur lisses épaisseur 6 mm

PANNELLO IN POLISTIRENE ALTA DENSITÀ INTERNO
High density Polystyrene internal panel
Panneaux en polystyrène intérieurs de haute densité

AEROGEL

SPIONCINO GRANDANGOLARE
Spyhole
Éilleton quadrangulaire

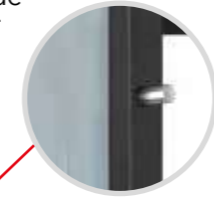

CHIAVISTELLO SUPERIORE IN ACCIAIO DIAM. 18 mm
Steel Top bolt 18 mm thickness
Pêne haut en acier diam 18 mm

TELAIO IN LAMIERA PREFILMATA CON PVC
Sheet metal inner frame PVC coated
Châssis en tôle protégé par pellicule PVC

CARENATURA PERIMETRALE IN LAMIERA PREFILMATA CON PVC
Sheet metal Perimetral profile PVC coated
Carénage de périmètre en tôle protégé par pellicule PVC



GRUPPO SERRATURA
Lock group
Groupe serrure

POZZETTI IN PVC SIA SUL LATO SERRATURA CHE SUL LATO CERNIERA
PVC pit lock side and hinges side
Puits en pvc côté serrure et côté paumelle



INCONTROSCROCCO AUTOREGISTRANTE
Self Registering latch
Verrou enregistrement automatique

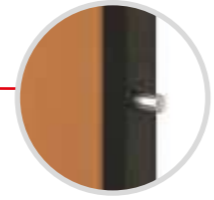

CHIAVISTELLO INFERIORE IN ACCIAIO DIAMETRO 18 mm
Steel bottom bolt 18 mm thickness
Pêne bas en acier diam 18 mm

CERNIERE A VISTA

VERSIONI

Versions
Versions

Thermal Steel N



DOPPIA MAPPA NON RICIFRABILE
Non recordable Double bit
Double bit non ré-chiffable

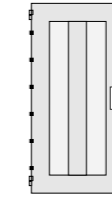

Thermal Steel R



DOPPIA MAPPA RICIFRABILE (CAMBIO FACILE CISA)
Recordable Double bit
Double bit ré-chiffable

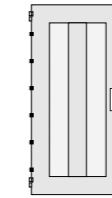

Thermal Steel C



CILINDRO EUROPEO
European Cylinder profile
Cylindre européen

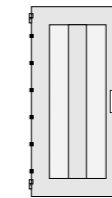

Thermal Steel CY



CILINDRO EUROPEO + CILINDRO DI SERVIZIO
European Cylinder profile + Service cylinder
cylindre européen + cylindre de service

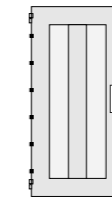

MISURE STANDARD

Standard Measures
Mesures standard

Larghezza / Width / Largeur:
cm 80 - 85 - 90

Altezza / Height / Hauteur:
cm 210

FUORI MISURA REALIZZABILI

Possible out of standard
Hors mesures réalisables

Larghezza / Width / Anchura:
da cm 50 a cm 110
from 50 cm to 110 cm
largeur de cm 50 à cm 110

Altezza / Height / Altura:
da cm 180 a cm 250
from 180 cm to 250 cm
hauteur de cm 180 à cm 250

Thermal Steel CS



DOPPIO CILINDRO EUROPEO CON BLOCCO
Double European Cylinder profile with security lock
Double cylindre européen avec blocage

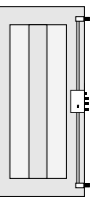

NOVITÀ

COMPATIBILE CON IL MODELLO FLAT

ISOLA SILVER

CLASSE 3 di antieffrazione UNI-EN 1627
Anti Burglary - Résistance à l'effraction

TRASMITTANZA TERMICA - 1,0 W/(m².K)
Thermic conduction - Transmission thermique

ABBATTIMENTO ACUSTICO - 40 dB
Acoustic performance - Affaiblissement acoustique

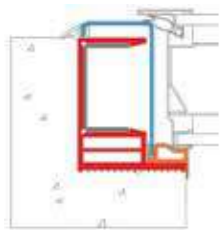

STRUTTURA COMPOSTA DA 1 FOGLIO + 5 OMEGA DI RINFORZO TUTTO IN LAMIERA ZINCATA
Galvanized steel frame made by 1 sheet metal + 5 reinforcements galvanized steel
Structure composée d'1 feuille + 5 oméga de renfort le tout en tôle galvanisée

SPIONCINO GRANDANGOLARE
Spyhole
Œilleton quadrangulaire

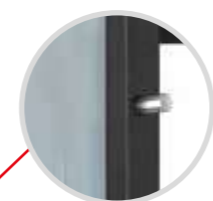

CHIAVISTELLO SUPERIORE IN ACCIAIO DIAM. 18 mm
Steel Top bolt 18 mm thickness
Pêne haut en acier diam 18 mm

N°6 ROSTRI FISSI SUL LATO CERNIERE IN ACCIAIO
6 Fixed Steel bolts hinges side
6 pènes fixes du côté paumelle en acier

TELAIO IN LAMIERA PREFILMATA CON PVC
Sheet metal inner frame PVC coated
Châssis en tôle protégé par pellicule PVC

CARENATURA PERIMETRALE IN LAMIERA PREFILMATA CON PVC
Sheet metal Perimetral profile PVC coated
Carénage de périmètre en tôle protégé par pellicule PVC

CERNIERE A SCOMPARSA

CERNIERA A SCOMPARSA REGISTRABILE SU 2 ASSI
2 axis External invisible adjustable hinges
Paumelle encastré enregistrable sur 2 axes

GRUPPO SERRATURA
Lock group
Groupe serrure

POZZETTI IN PVC SIA SUL LATO SERRATURA CHE SUL LATO CERNIERA
PVC pit lock side and hinges side
Puits en pvc côté serrure et côté paumelle

PARASPIFFERI INFERIORE REGISTRABILE + SPUGNA POLIURETANICA PER L'ABBATTIMENTO ACUSTICO
Bottom Movable Sill + polyurethane material for acoustic insulation
Revêtements intérieur et extérieur lisses épaisseur 6 mm

RIVESTIMENTO INTERNO ED ESTERNO LISCIO SP. 6 mm
Finishing flat internal and external panel 6 mm thickness
Revêtements intérieur et extérieur lisses épaisseur 6 mm

PANNELLO IN POLISTIRENE ALTA DENSITÀ INTERNO
High density Polystyrene internal panel
Panneaux en polystyrène intérieurs de haute densité

PANNELLO IN POLISTIRENE ALTA DENSITÀ INTERNO ED ESTERNO
High density Polystyrene internal and external panel
Panneaux en polystyrène intérieurs et extérieurs de haute densité

INCONTROSCROCCO AUTOREGISTRANTE
Self Registering latch
Verrou enregistrement automatique



CHIAVISTELLO INFERIORE IN ACCIAIO DIAMETRO 18 mm
Steel bottom bolt 18 mm thickness
Pêne bas en acier diam 18 mm

VERSIONI

Versions
Versiones

Isola Silver R



DOPPIA MAPPA NON RICIFRABILE (CAMBIO FACILE CISA)
Non recordable Double bit
Double bit non ré-chiffable

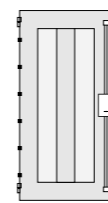

Isola Silver RS



GRUPPO DI CHIUSURA DI SICUREZZA A DOPPIA MAPPA RICIFRABILE
Recordable Double bit
Groupe de fermeture de sécurité à double bit ré-chiffable



Isola Silver C



CILINDRO EUROPEO
European Cylinder profile
Cylindre européen



Isola Silver CS



DOPPIO CILINDRO EUROPEO CON BLOCCO
Double European Cylinder profile with security lock
Double cylindre européen avec blocage



MISURE STANDARD

Standard Measures
Mesures standard

Larghezza / Width / Largeur:
cm 80 - 85 - 90

Altezza / Height / Hauteur:
cm 210

FUORI MISURA REALIZZABILI

Possible out of standard
Hors mesures réalisables

Larghezza / Width / Largeur :
da cm 50 a cm 110
from 50 cm to 110 cm
largeur de cm 50 à cm 110

Altezza / Height / Hauteur:
da cm 180 a cm 250
from 180 cm to 250 cm
hauteur de cm 180 à cm 250

SISTEMA BREVETTATO

Registered patented system
Système breveté

CERNIERA A SCOMPARSA ABSOLUTE
ABSOLUTE invisible hinge
Paumelle encastré Absolute



NOVITA

ISOLA STEEL

CLASSE 3 di antieffrazione UNI-EN 1627
Anti Burglary - Résistance à l'effraction

TRASMITTANZA TERMICA - 1,0 W/(m².K)
Thermic conduction - Transmission thermique

ABBATTIMENTO ACUSTICO - 40 dB
Acoustic performance - Affaiblissement acoustique

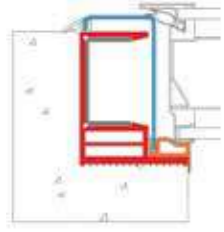

STRUTTURA COMPOSTA DA 1 FOGLIO + 5 OMEGA DI RINFORZO TUTTO IN LAMIERA ZINCATA
Galvanized steel frame made by 1 sheet metal + 5 reinforcements galvanized steel
Structure composée d'1 feuille + 5 oméga de renfort le tout en tôle galvanisée

N°6 ROSTRI FISSI SUL LATO CERNIERE IN ACCIAIO
6 Fixed Steel bolts hinges side
6 pènes fixes du côté paumelle en acier



CERNIERA A VISTA REGISTRABILE SU 2 ASSI
2 axis External adjustable hinges
Paumelle appliquée enregistrable sur 2 axes



PARASPIFFERI INFERIORE REGISTRABILE + SPUGNA POLIURETANICA PER L'ABBATTIMENTO ACUSTICO
Bottom Movable Sill + polyurethane material for acoustic insulation
Revêtements intérieur et extérieur lisses épaisseur 6 mm

RIVESTIMENTO INTERNO ED ESTERNO LISCIO SP. 6 mm
Finishing flat internal and external panel 6 mm thickness
Revêtements intérieur et extérieur lisses épaisseur 6 mm

PANNELLO IN POLISTIRENE ALTA DENSITÀ INTERNO
High density Polystyrene internal panel
Panneaux en polystyrène intérieurs de haute densité

PANNELLO IN POLISTIRENE ALTA DENSITÀ INTERNO ED ESTERNO
High density Polystyrene internal and external panel
Panneaux en polystyrène intérieurs et extérieurs de haute densité

SPIONCINO GRANDANGOLARE
Spyhole
Éilleton quadrangulaire

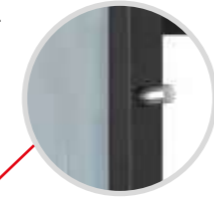

CHIAVISTELLO SUPERIORE IN ACCIAIO DIAM. 18 mm
Steel Top bolt 18 mm thickness
Pêne haut en acier diam 18 mm

TELAIO IN LAMIERA PREFILMATA CON PVC
Sheet metal inner frame PVC coated
Châssis en tôle protégé par pellicule PVC

CARENATURA PERIMETRALE IN LAMIERA PREFILMATA CON PVC
Sheet metal Perimetral profile PVC coated
Carénage de périmètre en tôle protégé par pellicule PVC



GRUPPO SERRATURA
Lock group
Groupe serrure

POZZETTI IN PVC SIA SUL LATO SERRATURA CHE SUL LATO CERNIERA
PVC pit lock side and hinges side
Puits en pvc côté serrure et côté paumelle



INCONTROSCROCCO AUTOREGISTRANTE
Self Registering latch
Verrou enregistrement automatique

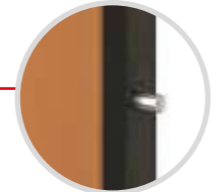

CHIAVISTELLO INFERIORE IN ACCIAIO DIAMETRO 18 mm
Steel bottom bolt 18 mm thickness
Pêne bas en acier diam 18 mm

CERNIERE A VISTA

VERSIONI

Versions
Versions

Isola Steel N



DOPPIA MAPPA NON RICIFRABILE
Non recordable Double bit
Double bit non ré-chiffable

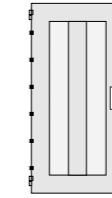

Isola Steel R



DOPPIA MAPPA RICIFRABILE (CAMBIO FACILE CISA)
Recordable Double bit
Double bit ré-chiffable

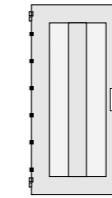

Isola Steel C



CILINDRO EUROPEO
European Cylinder profile
Cylindre européen

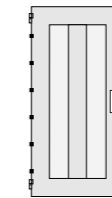

Isola Steel CY



CILINDRO EUROPEO + CILINDRO DI SERVIZIO
European Cylinder profile + Service cylinder
cylindre européen + cylindre de service

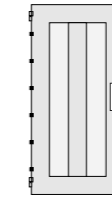

MISURE STANDARD

Standard Measures
Mesures standard

Larghezza / Width / Largeur:
cm 80 - 85 - 90

Altezza / Height / Hauteur:
cm 210

FUORI MISURA REALIZZABILI

Possible out of standard
Hors mesures réalisables

Larghezza / Width / Anchura:
da cm 50 a cm 110
from 50 cm to 110 cm
largeur de cm 50 à cm 110

Altezza / Height / Altura:
da cm 180 a cm 250
from 180 cm to 250 cm
hauteur de cm 180 à cm 250

Isola Steel CS



DOPPIO CILINDRO EUROPEO CON BLOCCO
Double European Cylinder profile with security lock
Double cylindre européen avec blocage

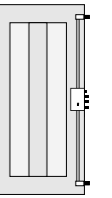

STEEL

CLASSE 3 di antieffrazione UNI-EN 1627
Anti Burglary - Résistance à l'effraction

TRASMITTANZA TERMICA - 1,3 W/(m².K)
Thermic conduction - Transmission thermique





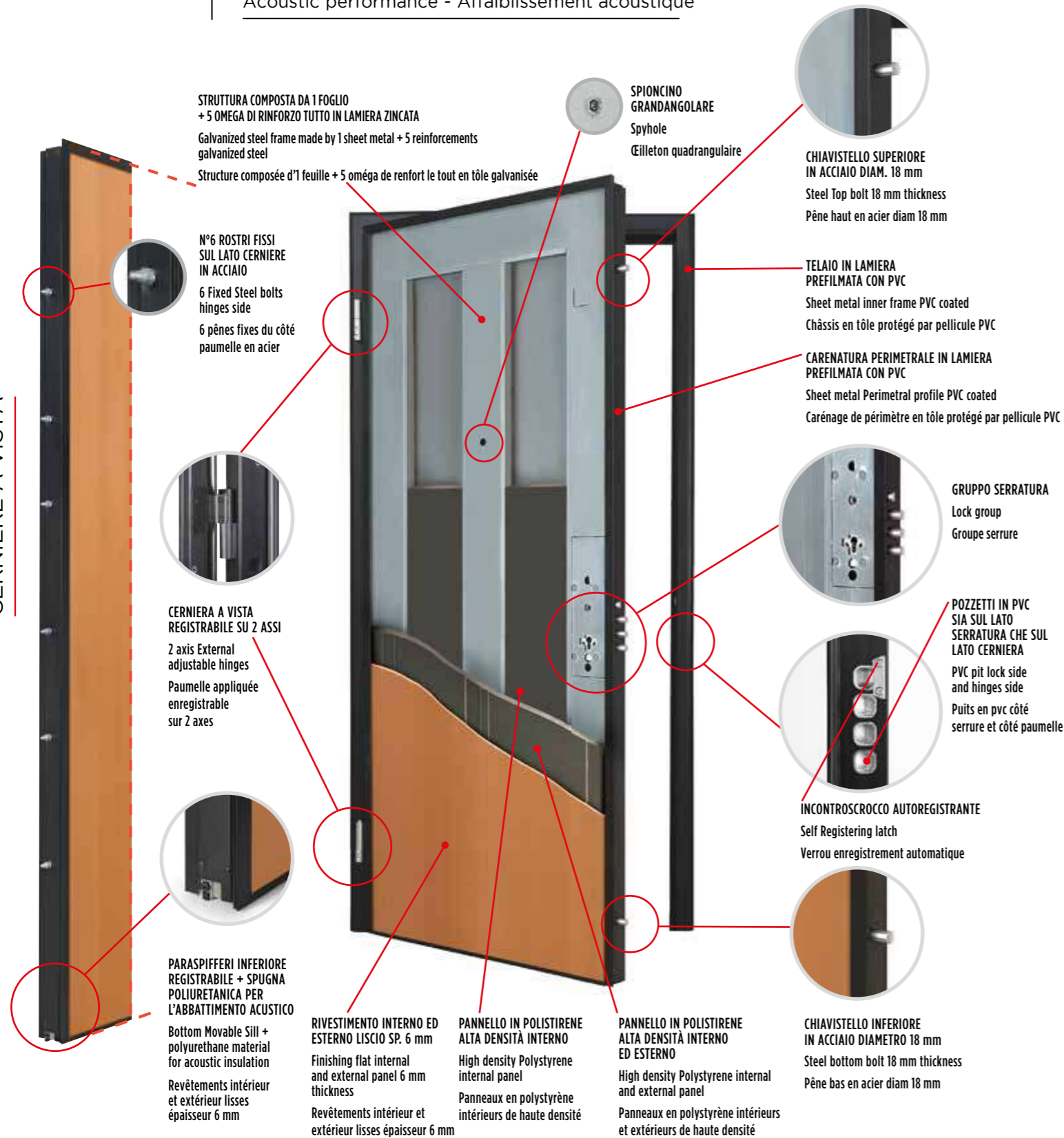

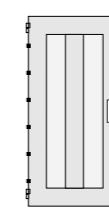

ABBATTIMENTO ACUSTICO - 34 dB
Acoustic performance - Affaiblissement acoustique

CERNIERE A VISTA

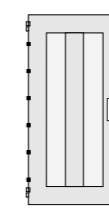

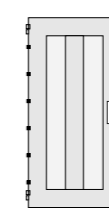
VERSIONI

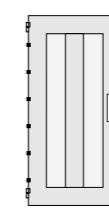
Versions
Versions

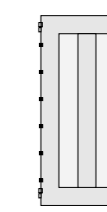
| | | |
|-----------------|--|---|
| Steel N | <p>DOPPIA MAPPA NON RICIFRABILE Non recordable Double bit Double bit non ré-chiffable</p>   | <p>MISURE STANDARD Standard Measures Mesures standard</p> <p>Larghezza / Width / Largeur: cm 80 - 85 - 90</p> <p>Altezza / Height / Hauteur: cm 210</p> |
| Steel R | <p>DOPPIA MAPPA RICIFRABILE (CAMBIO FACILE CISA) Recordable Double bit Double bit ré-chiffable</p>   | <p>FUORI MISURA REALIZZABILI Possible out of standard Hors mesures réalisables</p> <p>Larghezza / Width / Anchura: da cm 50 a cm 110 from 50 cm to 110 cm largeur de cm 50 à cm 110</p> <p>Altezza / Height / Altura: da cm 180 a cm 250 from 180 cm to 250 cm hauteur de cm 180 à cm 250</p> |
| Steel C | <p>CILINDRO EUROPEO European Cylinder profile Cylindre européen</p>   | |
| Steel CY | <p>CILINDRO EUROPEO + CILINDRO DI SERVIZIO European Cylinder profile + Service cylinder cylindre européen + cylindre de service</p>   | <p>Steel CS</p> <p>DOPPIO CILINDRO EUROPEO CON BLOCCO Double European Cylinder profile with security lock Double cylindre européen avec blocage</p>   |

STEEL PLUS

CLASSE 3 di antieffrazione UNI-EN 1627
Anti Burglary - Résistance à l'effraction

TRASMITTANZA TERMICA - 1,3 W/(M².K)
Thermic conduction - Transmission thermique

ABBATTIMENTO ACUSTICO - 34 dB
Acoustic performance - Affaiblissement acoustique

CERNIERE A VISTA

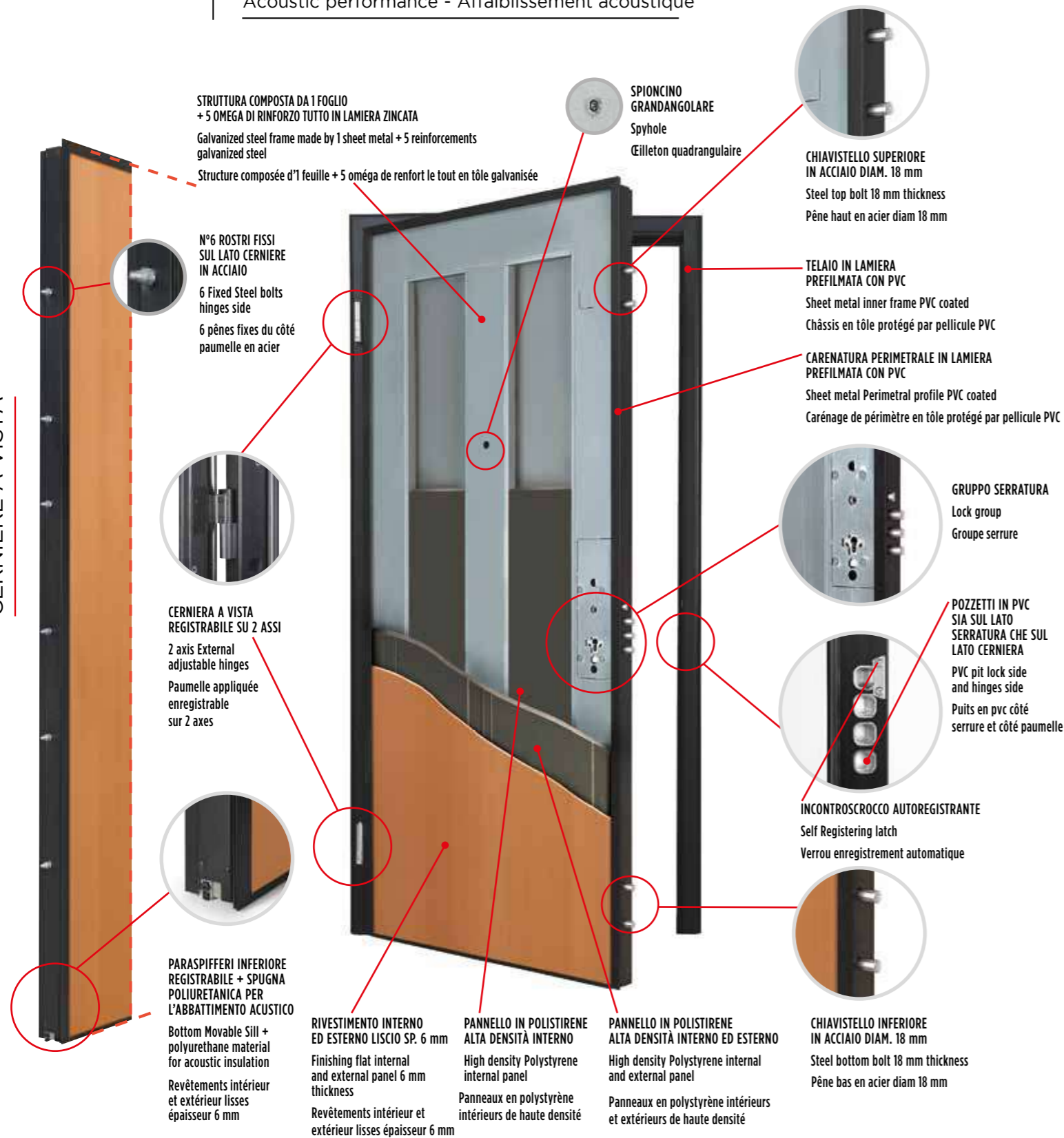

STRUTTURA COMPOSTA DA 1 FOGLIO + 5 OMEGA DI RINFORZO TUTTO IN LAMIERA ZINCATA
Galvanized steel frame made by 1 sheet metal + 5 reinforcements galvanized steel
Structure composée d'1 feuille + 5 oméga de renfort le tout en tôle galvanisée

N°6 ROSTRI FISSI SUL LATO CERNIERE IN ACCIAIO
6 Fixed Steel bolts hinges side
6 pènes fixes du côté paumelle en acier

CERNIERA A VISTA REGISTRABILE SU 2 ASSI
2 axis External adjustable hinges
Paumelle appliquée enregistrable sur 2 axes

PARASPIFFERI INFERIORE REGISTRABILE + SPUGNA POLIURETANICA PER L'ABBATTIMENTO ACUSTICO
Bottom Movable Sill + polyurethane material for acoustic insulation
Revêtements intérieur et extérieur lisses épaisseur 6 mm

RIVESTIMENTO INTERNO ED ESTERNO LISCIO SP. 6 mm
Finishing flat internal and external panel 6 mm thickness
Revêtements intérieur et extérieur lisses épaisseur 6 mm

PANNELLO IN POLISTIRENE ALTA DENSITÀ INTERNO
High density Polystyrene internal panel
Panneaux en polystyrène intérieurs de haute densité

PANNELLO IN POLISTIRENE ALTA DENSITÀ INTERNO ED ESTERNO
High density Polystyrene internal and external panel
Panneaux en polystyrène intérieurs et extérieurs de haute densité

SPIONCINO GRANDANGOLARE
Spyhole
Élillon quadrangulaire

CHIAVISTELLO SUPERIORE IN ACCIAIO DIAM. 18 mm
Steel top bolt 18 mm thickness
Pêne haut en acier diam 18 mm

TELAIO IN LAMIERA PREFILMATA CON PVC
Sheet metal inner frame PVC coated
Châssis en tôle protégé par pellicule PVC

CARENATURA PERIMETRALE IN LAMIERA PREFILMATA CON PVC
Sheet metal Perimetral profile PVC coated
Carénage de périmètre en tôle protégé par pellicule PVC

GRUPPO SERRATURA
Lock group
Groupe serrure

POZZETTI IN PVC SIA SUL LATO SERRATURA CHE SUL LATO CERNIERA
PVC pit lock side and hinges side
Puits en pvc côté serrure et côté paumelle

INCONTROSCROCCO AUTOREGISTRANTE
Self Registering latch
Verrou enregistrement automatique

CHIAVISTELLO INFERIORE IN ACCIAIO DIAM. 18 mm
Steel bottom bolt 18 mm thickness
Pêne bas en acier diam 18 mm

VERSIONI

Versions
Versions

Steel C Plus



CILINDRO EUROPEO (CAMBIO FACILE CISA) CON DOPPIO DEVIATORE INFERIORE E SUPERIORE

European Cylinder with double top and bottom bolts
Cylindre européen avec double déviateur inférieur et supérieur

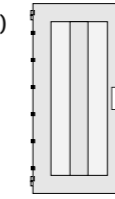

Steel CY Plus



CILINDRO EUROPEO + CILINDRO DI SERVIZIO
European Cylinder profile + Service cylinder
Cylindre européen + cylindre de service

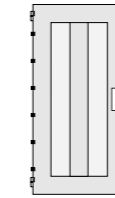

Steel CS Plus



CILINDRO EUROPEO + CILINDRO DI SERVIZIO
European Cylinder profile + Service cylinder
Cylindre européen + cylindre de service

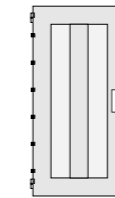

MISURE STANDARD

Standard Measures
Mesures standard

Larghezza / Width / Largeur:
cm 80 - 85 - 90

Altezza / Height / Hauteur:
cm 210

FUORI MISURA REALIZZABILI

Possible out of standard
Hors mesures réalisables

Larghezza / Width / Largeur:
da cm 50 a cm 110
from 50 cm to 110 cm
largeur de cm 50 à cm 110

Altezza / Height / Hauteur:
da cm 180 a cm 250
from 180 cm to 250 cm
hauteur de cm 180 à cm 250

VEGA PLUS

CLASSE 4 di antieffrazione UNI-EN 1627
Anti Burglary - Résistance à l'effraction

TRASMITTANZA TERMICA - 1,8 W/(M².K)
Thermic conduction - Transmission thermique

ABBATTIMENTO ACUSTICO - 34 dB
Acoustic performance - Affaiblissement acoustique

CERNIERE A VISTA

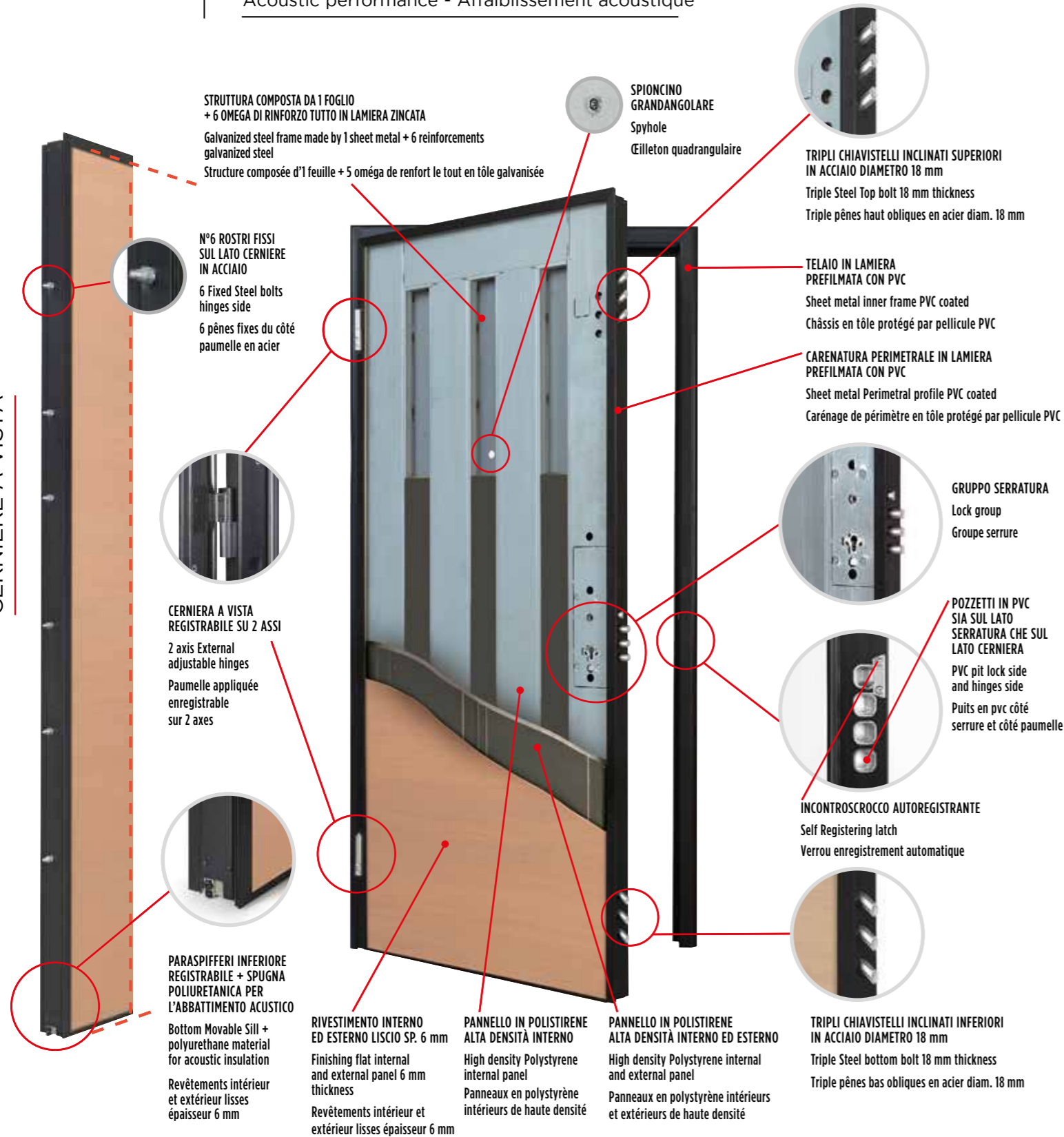

STRUTTURA COMPOSTA DA 1 FOGLIO + 6 OMEGA DI RINFORZO TUTTO IN LAMIERA ZINCATA
Galvanized steel frame made by 1 sheet metal + 6 reinforcements galvanized steel
Structure composée d'1 feuille + 5 oméga de renfort le tout en tôle galvanisée

N°6 ROSTRI FISSI SUL LATO CERNIERE IN ACCIAIO
6 Fixed Steel bolts hinges side
6 pènes fixes du côté paumelle en acier

CERNIERA A VISTA REGISTRABILE SU 2 ASSI
2 axis External adjustable hinges
Paumelle appliquée enregistrable sur 2 axes

PARASPIFFERI INFERIORE REGISTRABILE + SPUGNA POLIURETANICA PER L'ABBATTIMENTO ACUSTICO
Bottom Movable Sill + polyurethane material for acoustic insulation
Revêtements intérieur et extérieur lisses épaisseur 6 mm

RIVESTIMENTO INTERNO ED ESTERNO LISCIO SP. 6 mm
Finishing flat internal and external panel 6 mm thickness
Revêtements intérieur et extérieur lisses épaisseur 6 mm

PANNELLO IN POLISTIRENE ALTA DENSITÀ INTERNO
High density Polystyrene internal panel
Panneaux en polystyrène intérieurs de haute densité

PANNELLO IN POLISTIRENE ALTA DENSITÀ INTERNO ED ESTERNO
High density Polystyrene internal and external panel
Panneaux en polystyrène intérieurs et extérieurs de haute densité

SPIONCINO GRANDANGOLARE
Spyhole
Écilleton quadrangulaire

TRIPLI CHIAVISTELLI INCLINATI SUPERIORI IN ACCIAIO DIAMETRO 18 mm
Triple Steel Top bolt 18 mm thickness
Triple pènes haut obliques en acier diam. 18 mm

TELAIO IN LAMIERA PREFILMATA CON PVC
Sheet metal inner frame PVC coated
Châssis en tôle protégé par pellicule PVC

CARENATURA PERIMETRALE IN LAMIERA PREFILMATA CON PVC
Sheet metal Perimetral profile PVC coated
Carénage de périmètre en tôle protégé par pellicule PVC

GRUPPO SERRATURA
Lock group
Groupe serrure

POZZETTI IN PVC SIA SUL LATO SERRATURA CHE SUL LATO CERNIERA
PVC pit lock side and hinges side
Puits en pvc côté serrure et côté paumelle

INCONTROSCROCCO AUTOREGISTRANTE
Self Registering latch
Verrou enregistrement automatique

TRIPLI CHIAVISTELLI INCLINATI INFERIORI IN ACCIAIO DIAMETRO 18 mm
Triple Steel bottom bolt 18 mm thickness
Triple pènes bas obliques en acier diam. 18 mm

VERSIONI

Versions
Versions

Vega Plus C



CILINDRO EUROPEO
European Cylinder profile
Cylindre européen

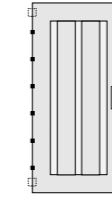

Vega Plus CS



DOPPIO CILINDRO EUROPEO CON BLOCCO
Double European Cylinder profile with security lock
Double cylindre européen avec blocage

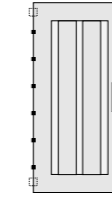

MISURE STANDARD

Standard Measures
Mesures standard

Larghezza / Width / Largeur:
cm 80 - 85 - 90

Altezza / Height / Hauteur:
cm 210

FUORI MISURA REALIZZABILI

Possible out of standard
Hors mesures réalisables

Larghezza / Width / Largeur :
da cm 50 a cm 110
from 50 cm to 110 cm
largeur de cm 50 à cm 110

Altezza / Height / Hauteur :
da cm 180 a cm 250
from 180 cm to 250 cm
hauteur de cm 180 à cm 250

STEEL FB6

RESISTENZA AL PROIETTILE EN 1522
FB6 FINO AL CALIBRO 7,62 X 51 FJ

Bullet resistance FB6 till Caliber 7.62x51 FJ
according to rule EN1522

Résistance au projectile EN1522 FB6
jusqu'à un calibre 7,62 X 51 FJ

CLASSE 3 di antieffrazione UNI-EN 1627
Anti Burglary - Résistance à l'effraction

TRASMITTANZA TERMICA - 1,8 W/(M².K)
Thermic conduction - Transmission thermique

ABBATTIMENTO ACUSTICO - 34 dB
Acoustic performance - Affaiblissement acoustique

CERNIERE A VISTA

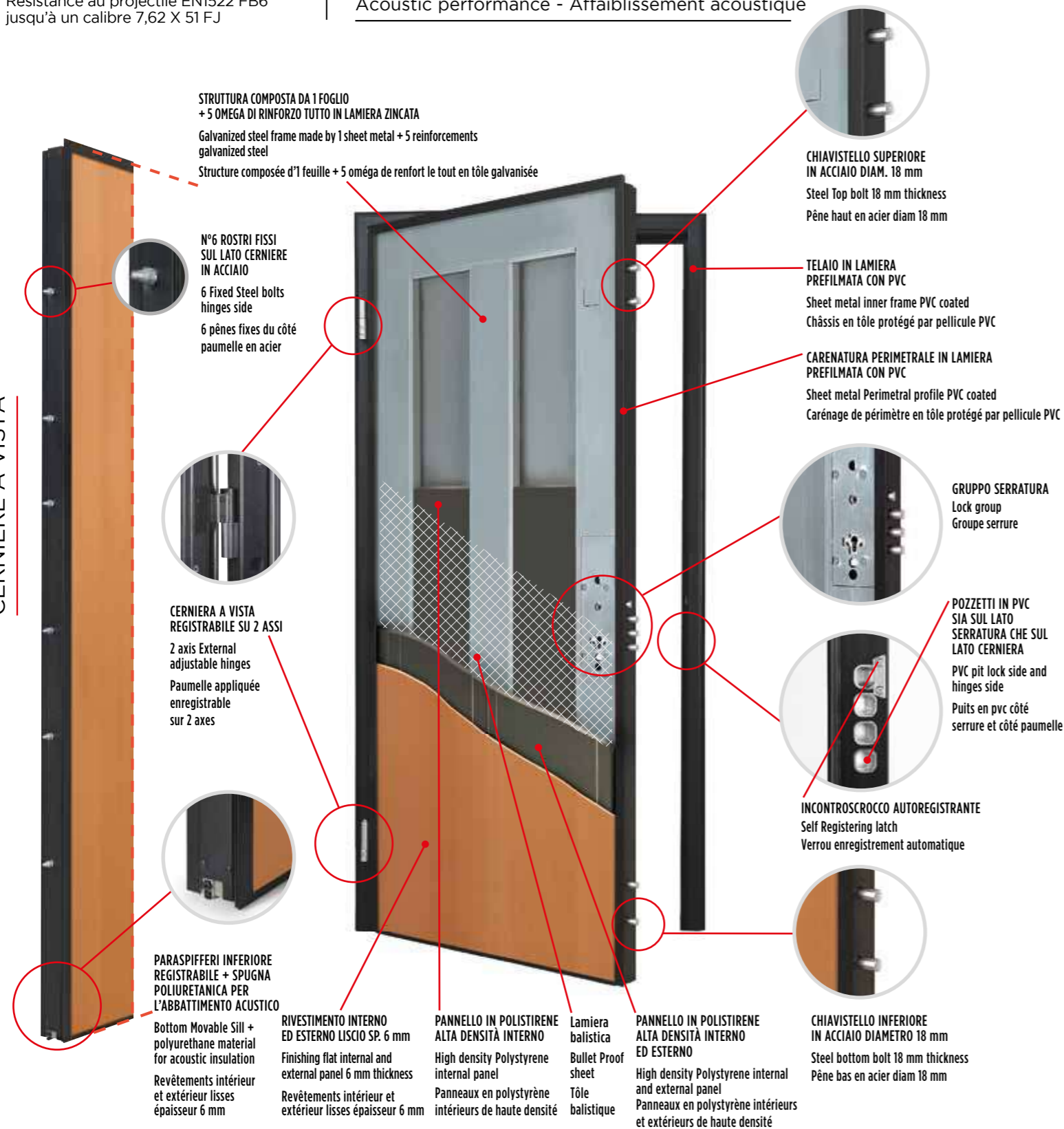

SEZIONE ORIZZONTALE NODO LATO SERRATURA

Horizontal section lock side
Section horizontale noyau côté serrure

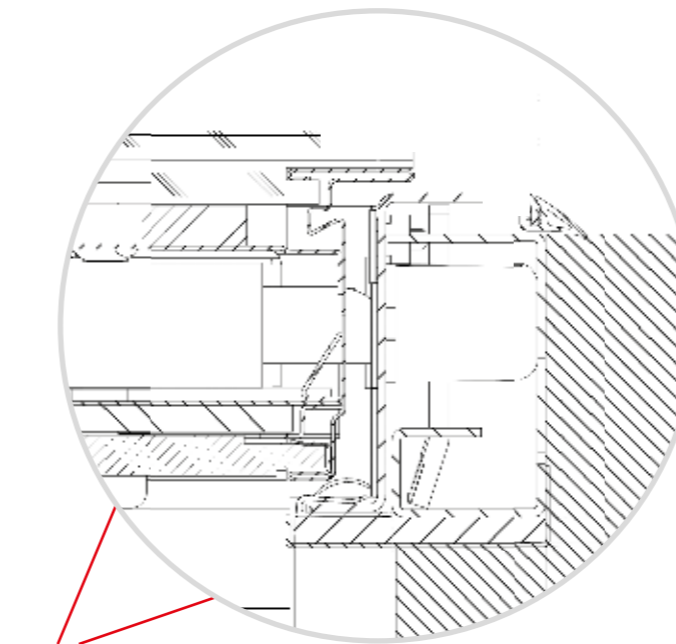

Lamiera balistica
Bullet Proof sheet
Tôle balistique

MISURE STANDARD

Standard Measures
Mesures standard

Larghezza / Width / Largeur:
cm 80 - 85 - 90

Altezza / Height / Hauteur:
cm 210

FUORI MISURA REALIZZABILI

Possible out of standard
Hors mesures réalisables

Larghezza / Width / Largeur :
da cm 50 a cm 110
from 50 cm to 110 cm
largeur de cm 50 à cm 110

Altezza / Height / Hauteur :
da cm 180 a cm 250
from 180 cm to 250 cm
hauteur de cm 180 à cm 250

DUO

CLASSE 3 di antieffrazione UNI-EN 1627
Anti Burglary - Résistance à l'effraction

TRASMITTANZA TERMICA - 1,4 W/(m².K)
Thermic conduction - Transmission thermique

ABBATTIMENTO ACUSTICO - 36 dB
Acoustic performance - Affaiblissement acoustique

STRUTTURA COMPOSTA DA 1 FOGLIO
+ 5 OMEGA DI RINFORZO TUTTO IN LAMIERA ZINCATA
Galvanized steel frame made by 1 sheet metal + 5 reinforcements
galvanized steel
Structure composée d'1 feuille + 5 oméga de renfort le tout en tôle galvanisée

N°6 ROSTRI FISSI
SUL LATO CERNIERE
IN ACCIAIO
6 Fixed Steel bolts
hinges side
6 pènes fixes du côté
paumelle en acier



CERNIERA A VISTA
REGISTRABILE SU 2 ASSI
2 axis External
adjustable hinges
Paumelle appliquée
enregistrable
sur 2 axes



PARASPIFFERI INFERIORE
REGISTRABILE + SPUGNA
POLIURETANICA PER
L'ABBATTIMENTO ACUSTICO
Bottom Movable Sill +
polyurethane material
for acoustic insulation
Revêtements intérieur
et extérieur lisses
épaisseur 6 mm

RIVESTIMENTO INTERNO ED
ESTERNO LISCIO SP. 6 mm
Finishing flat internal
and external panel 6 mm
thickness
Revêtements intérieur et
extérieur lisses épaisseur 6 mm

PANNELLO IN POLISTIRENE
ALTA DENSITÀ INTERNO
High density Polystyrene
internal panel
Panneaux en polystyrène
intérieurs de haute densité

PANNELLO IN POLISTIRENE
ALTA DENSITÀ INTERNO
ED ESTERNO
High density Polystyrene internal
and external panel
Panneaux en polystyrène intérieurs
et extérieurs de haute densité

SPIONCINO
GRANDANGOLARE
Spyhole
Œilleton quadrangulaire

CHIAVISTELLO SUPERIORE
IN ACCIAIO DIAM. 18 mm
Steel Top bolt 18 mm thickness
Pêne haut en acier diam 18 mm

TELAIO IN LAMIERA
PREFILMATA CON PVC
Sheet metal inner frame PVC coated
Châssis en tôle protégé par pellicule PVC

N°6 ROSTRI FISSI
SUL LATO CERNIERE
IN ACCIAIO
6 Fixed Steel bolts
hinges side
6 pènes fixes du côté
paumelle en acier



GRUPPO SERRATURA
Lock group / Groupe serrure



CARENATURA PERIMETRALE IN
LAMIERA PREFILMATA CON PVC
Sheet metal Perimetral profile
PVC coated
Carénage de périmètre en tôle
protégé par pellicule PVC

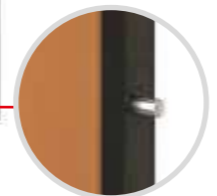

CHIAVISTELLO INFERIORE
IN ACCIAIO DIAMETRO 18 mm
Steel bottom bolt 18 mm
thickness
Pêne bas en acier diam 18 mm

VERSIONI

Versions
Versions

Duo R



DOPPIA MAPPA RICIFRABILE
(CAMBIO FACILE CISA)

Recordable Double bit
Double bit ré-chiffable

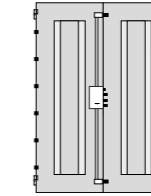

Duo C



CILINDRO EUROPEO
European Cylinder profile
Cylindre européen

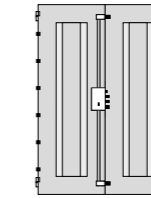

Optional

Serratura CY e CS



CILINDRO EUROPEO
+ CILINDRO DI SERVIZIO
European Cylinder profile
+ Service cylinder
Cylindre européen
+ cylindre de service

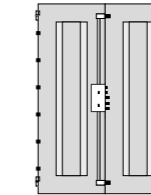

MISURE STANDARD

Standard Measures
Mesures standard

Larghezza asimmetrica / Asymmetrical width
Largeur asymétrique:
cm 80 - 85 - 90 + cm 30 - 35 - 40

Larghezza simmetrica / Symmetrical width
Largeur symétrique:
cm 50 - 60 - 65 + cm 50 - 60 - 65

Altezza / Height / Altura:
cm 210

FUORI MISURA REALIZZABILI

Possible out of standard
Hors mesures réalisables

Larghezza / Width / Largeur:
da cm 50 a cm 110
from 50 cm to 110 cm
desde 50 cm hasta 110 cm

Altezza / Height / Hauteur:
da cm 180 a cm 250
from 180 cm to 250 cm
desde 180 cm hasta 250 cm

SILVER

CLASSE 3 di antieffrazione UNI-EN 1627
Anti Burglary - Résistance à l'effraction

TRASMITTANZA TERMICA - 1,3 W/(M².K)
Thermic conduction - Transmission thermique

ABBATTIMENTO ACUSTICO - 34 dB
Acoustic performance - Affaiblissement acoustique

**COMPATIBILE CON
IL MODELLO FLAT**

CERNIERE A SCOMPARSA

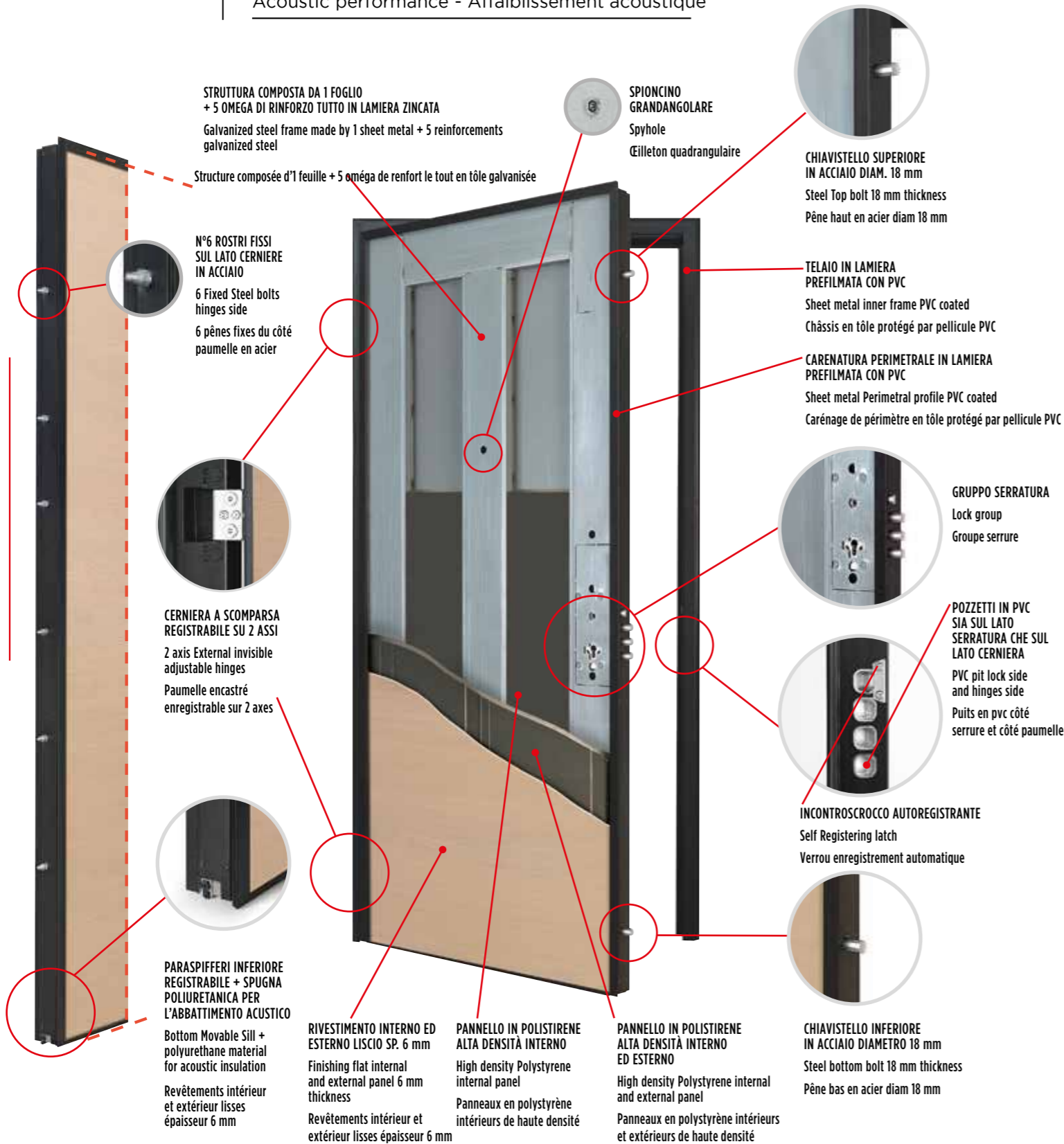

VERSIONI

Versions
Versiones

| | | |
|------------------|--|--|
| Silver R | DOPPIA MAPPA NON RICIFRABILE (CAMBIO FACILE CISA) Non recordable Double bit Double bit non ré-chiffable | |
| Silver RS | GRUPPO DI CHIUSURA DI SICUREZZA A DOPPIA MAPPA RICIFRABILE Recordable Double bit Groupe de fermeture de sécurité à double bit ré-chiffable | |
| Silver C | CILINDRO EUROPEO European Cylinder profile Cylindre européen | |
| Silver CS | DOPPIO CILINDRO EUROPEO CON BLOCCO Double European Cylinder profile with security lock Double cylindre européen avec blocage | |

MISURE STANDARD

Standard Measures
Mesures standard

Larghezza / Width / Largeur:
cm 80 - 85 - 90

Altezza / Height / Hauteur:
cm 210

FUORI MISURA REALIZZABILI

Possible out of standard
Hors mesures réalisables

Larghezza / Width / Largeur :
da cm 50 a cm 110
from 50 cm to 110 cm

largueur de cm 50 à cm 110

Altezza / Height / Hauteur:
da cm 180 a cm 250
from 180 cm to 250 cm

hauteur de cm 180 à cm 250

SISTEMA BREVETTATO

Registered patented system
Système breveté

CERNIERA A SCOMPARSA ABSOLUTE
ABSOLUTE invisible hinge
Paumelle encastré Absolute

GOLD

CLASSE 3 di antieffrazione UNI-EN 1627
Anti Burglary - Résistance à l'effraction

TRASMITTANZA TERMICA - 1,3 W/(M².K)
Thermic conduction - Transmission thermique

ABBATTIMENTO ACUSTICO - 34 dB
Acoustic performance - Affaiblissement acoustique

**COMPATIBILE CON
IL MODELLO FLAT**

CERNIERE A SCOMPARSA

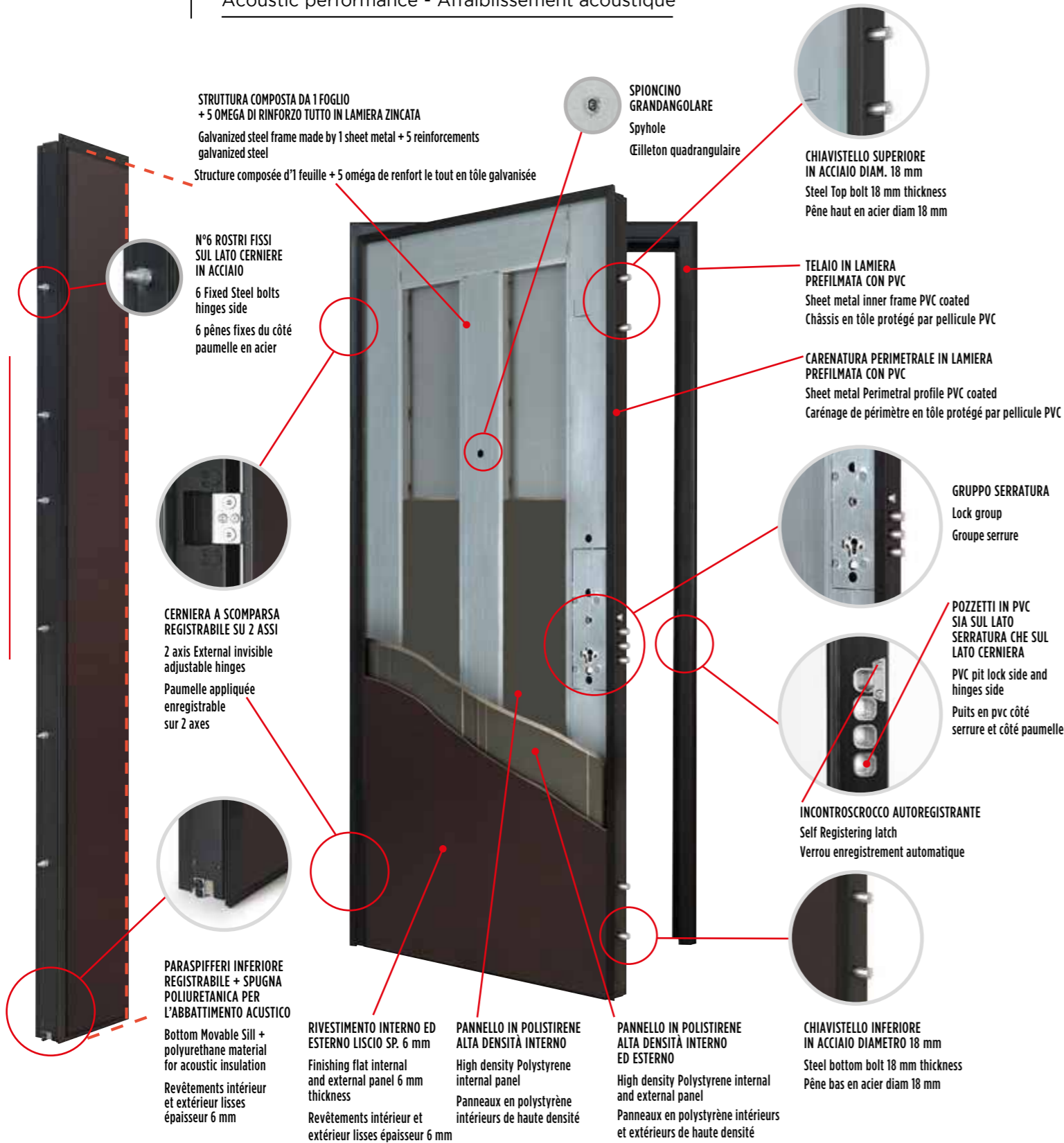

STRUTTURA COMPOSTA DA 1 FOGLIO
+ 5 OMEGA DI RINFORZO TUTTO IN LAMIERA ZINCATA
Galvanized steel frame made by 1 sheet metal + 5 reinforcements
galvanized steel
Structure composée d'1 feuille + 5 oméga de renfort le tout en tôle galvanisée

N°6 ROSTRI FISSI
SUL LATO CERNIERE
IN ACCIAIO
6 Fixed Steel bolts
hinges side
6 pènes fixes du côté
paumelle en acier

CERNIERA A SCOMPARSA
REGISTRABILE SU 2 ASSI
2 axis External invisible
adjustable hinges
Paumelle appliquée
enregistrable
sur 2 axes

PARASPIFFERI INFERIORE
REGISTRABILE + SPUGNA
POLIURETANICA PER
L'ABBATTIMENTO ACUSTICO
Bottom Movable Sill +
polyurethane material
for acoustic insulation
Revêtements intérieur
et extérieur lisses
épaisseur 6 mm

RIVESTIMENTO INTERNO ED
ESTERNO LISCIO SP. 6 mm
Finishing flat internal
and external panel 6 mm
thickness
Revêtements intérieur et
extérieur lisses épaisseur 6 mm

PANNELLO IN POLISTIRENE
ALTA DENSITÀ INTERNO
High density Polystyrene
internal panel
Panneaux en polystyrène
intérieurs de haute densité

PANNELLO IN POLISTIRENE
ALTA DENSITÀ INTERNO
ED ESTERNO
High density Polystyrene internal
and external panel
Panneaux en polystyrène intérieurs
et extérieurs de haute densité

SPIONCINO
GRANDANGOLARE
Spyhole
Cilletton quadrangulaire

CHIAVISTELLO SUPERIORE
IN ACCIAIO DIAM. 18 mm
Steel Top bolt 18 mm thickness
Pêne haut en acier diam 18 mm

TELAIO IN LAMIERA
PREFILMATA CON PVC
Sheet metal inner frame PVC coated
Châssis en tôle protégé par pellicule PVC

CARENATURA PERIMETRALE IN LAMIERA
PREFILMATA CON PVC
Sheet metal Perimetral profile PVC coated
Carénage de périmètre en tôle protégé par pellicule PVC

GRUPPO SERRATURA
Lock group
Groupe serrure

POZZETTI IN PVC
SIA SUL LATO
SERRATURA CHE SUL
LATO CERNIERA
PVC pit lock side and
hinges side
Puits en pvc côté
serrure et côté paumelle

INCONTROSCROCCO AUTOREGISTRANTE
Self Registering latch
Verrou enregistrement automatique

CHIAVISTELLO INFERIORE
IN ACCIAIO DIAMETRO 18 mm
Steel bottom bolt 18 mm thickness
Pêne bas en acier diam 18 mm

VERSIONI

Versions
Versions

Gold R



DOPPIA MAPPA NON RICIFRABILE
(CAMBIO FACILE CISA)
Non recordable Double bit
Double bit non ré-chiffirable

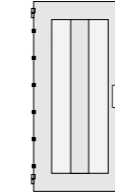

Gold RS



GRUPPO DI CHIUSURA DI SICUREZZA
A DOPPIA MAPPA RICIFRABILE
Recordable Double bit
Groupe de fermeture de sécurité
à double bit ré-chiffirable

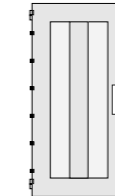

Gold C



CILINDRO EUROPEO
European Cylinder profile
Cylindre européen

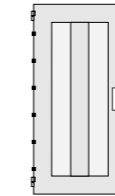

Gold CS



DOPPIO CILINDRO EUROPEO
CON BLOCCO
Double European Cylinder profile
with security lock
Double cylindre européen avec blocage

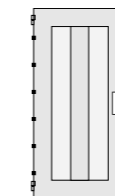

MISURE STANDARD

Standard Measures
Mesures standard

Larghezza / Width / Largeur:
cm 80 - 85 - 90

Altezza / Height / Hauteur:
cm 210

FUORI MISURA REALIZZABILI

Possible out of standard
Hors mesures réalisables

Larghezza / Width / Largeur :
da cm 50 a cm 110
from 50 cm to 110 cm
largeur de cm 50 à cm 110

Altezza / Height / Hauteur:
da cm 180 a cm 250
from 180 cm to 250 cm
hauteur de cm 180 à cm 250

SISTEMA BREVETTATO

Registered patented system
Système breveté

CERNIERA A SCOMPARSA ABSOLUTE
ABSOLUTE invisible hinge
Paumelle encastré Absolute



PLATINUM

CLASSE 4 di antieffrazione UNI-EN 1627
Anti Burglary - Résistance à l'effraction

TRASMITTANZA TERMICA - 1,8 W/(M².K)
Thermic conduction - Transmission thermique

ABBATTIMENTO ACUSTICO - 34 dB
Acoustic performance - Affaiblissement acoustique

**COMPATIBILE CON
IL MODELLO FLAT**

CERNIERE A SCOMPARSA

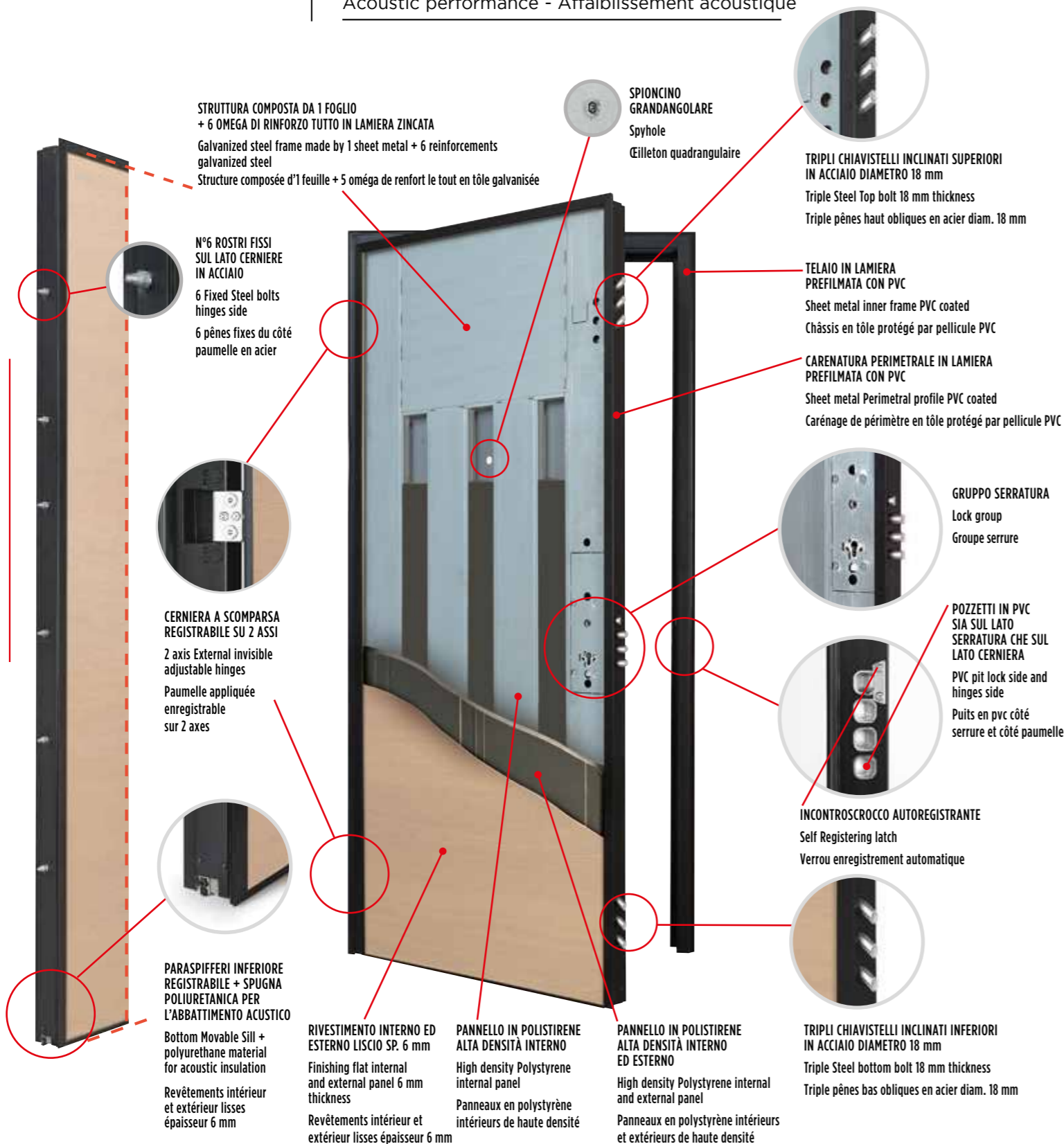

STRUTTURA COMPOSTA DA 1 FOGLIO + 6 OMEGA DI RINFORZO TUTTO IN LAMIERA ZINCATA
Galvanized steel frame made by 1 sheet metal + 6 reinforcements galvanized steel
Structure composée d'1 feuille + 5 oméga de renfort le tout en tôle galvanisée

N°6 ROSTRI FISSI SUL LATO CERNIERE IN ACCIAIO
6 Fixed Steel bolts hinges side
6 pènes fixes du côté paumelle en acier

CERNIERA A SCOMPARSA REGISTRABILE SU 2 ASSI
2 axis External invisible adjustable hinges
Paumelle appliquée enregistrable sur 2 axes

PARASPIFFERI INFERIORE REGISTRABILE + SPUGNA POLIURETANICA PER L'ABBATTIMENTO ACUSTICO
Bottom Movable Sill + polyurethane material for acoustic insulation
Revêtements intérieur et extérieur lisses épaisseur 6 mm

RIVESTIMENTO INTERNO ED ESTERNO LISCIO SP. 6 mm
Finishing flat internal and external panel 6 mm thickness
Revêtements intérieur et extérieur lisses épaisseur 6 mm

PANNELLO IN POLISTIRENE ALTA DENSITÀ INTERNO
High density Polystyrene internal panel
Panneaux en polystyrène intérieurs de haute densité

PANNELLO IN POLISTIRENE ALTA DENSITÀ INTERNO ED ESTERNO
High density Polystyrene internal and external panel
Panneaux en polystyrène intérieurs et extérieurs de haute densité

SPIONCINO GRANDANGOLARE
Spyhole
Cilletton quadrangulaire

TRIPLI CHIAVISTELLI INCLINATI SUPERIORI IN ACCIAIO DIAMETRO 18 mm
Triple Steel Top bolt 18 mm thickness
Triple pènes haut obliques en acier diam. 18 mm

TELAIO IN LAMIERA PREFILMATA CON PVC
Sheet metal inner frame PVC coated
Châssis en tôle protégé par pellicule PVC

CARENATURA PERIMETRALE IN LAMIERA PREFILMATA CON PVC
Sheet metal Perimetral profile PVC coated
Carénage de périmètre en tôle protégé par pellicule PVC

GRUPPO SERRATURA
Lock group
Groupe serrure

POZZETTI IN PVC SIA SUL LATO SERRATURA CHE SUL LATO CERNIERA
PVC pit lock side and hinges side
Puits en pvc côté serrure et côté paumelle

INCONTROSCROCCO AUTOREGISTRANTE
Self Registering latch
Verrou enregistrement automatique

TRIPLI CHIAVISTELLI INCLINATI INFERIORI IN ACCIAIO DIAMETRO 18 mm
Triple Steel bottom bolt 18 mm thickness
Triple pènes bas obliques en acier diam. 18 mm

VERSIONI

Versions
Versions

Platinum C



CILINDRO EUROPEO
European Cylinder profile
Cylindre européen

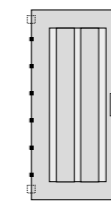

Platinum CS



DOPPIO CILINDRO EUROPEO CON BLOCCO
Double European Cylinder profile with security lock
Double cylindre européen avec blocage

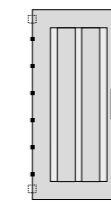

MISURE STANDARD

Standard Measures
Medidas estandar

Larghezza / Width / Largeur:
cm 80 - 85 - 90

Altezza / Height / Hauteur:
cm 210

FUORI MISURA REALIZZABILI

Possible out of standard
Medidas no estandar que se pueden realizar

Larghezza / Width / Largeur:
da cm 50 a cm 110
from 50 cm to 110 cm
largeur de cm 50 à cm 110

Altezza / Height / Hauteur:
da cm 180 a cm 250
from 180 cm to 250 cm
hauteur de cm 180 à cm 250

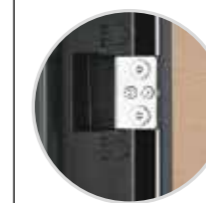

SISTEMA BREVETTATO

Registered patented system
Système breveté

CERNIERA A SCOMPARSA ABSOLUTE
ABSOLUTE invisible hinge
Paumelle encastré Absolute

TITANIUM

CLASSE 4 di antieffrazione UNI-EN 1627
Anti Burglary - Résistance à l'effraction

TRASMITTANZA TERMICA - 1,8 W/(M².K)
Thermic conduction - Transmission thermique

ABBATTIMENTO ACUSTICO - 34 dB
Acoustic performance - Affaiblissement acoustique

**COMPATIBILE CON
IL MODELLO FLAT**

CERNIERE A SCOMPARSA

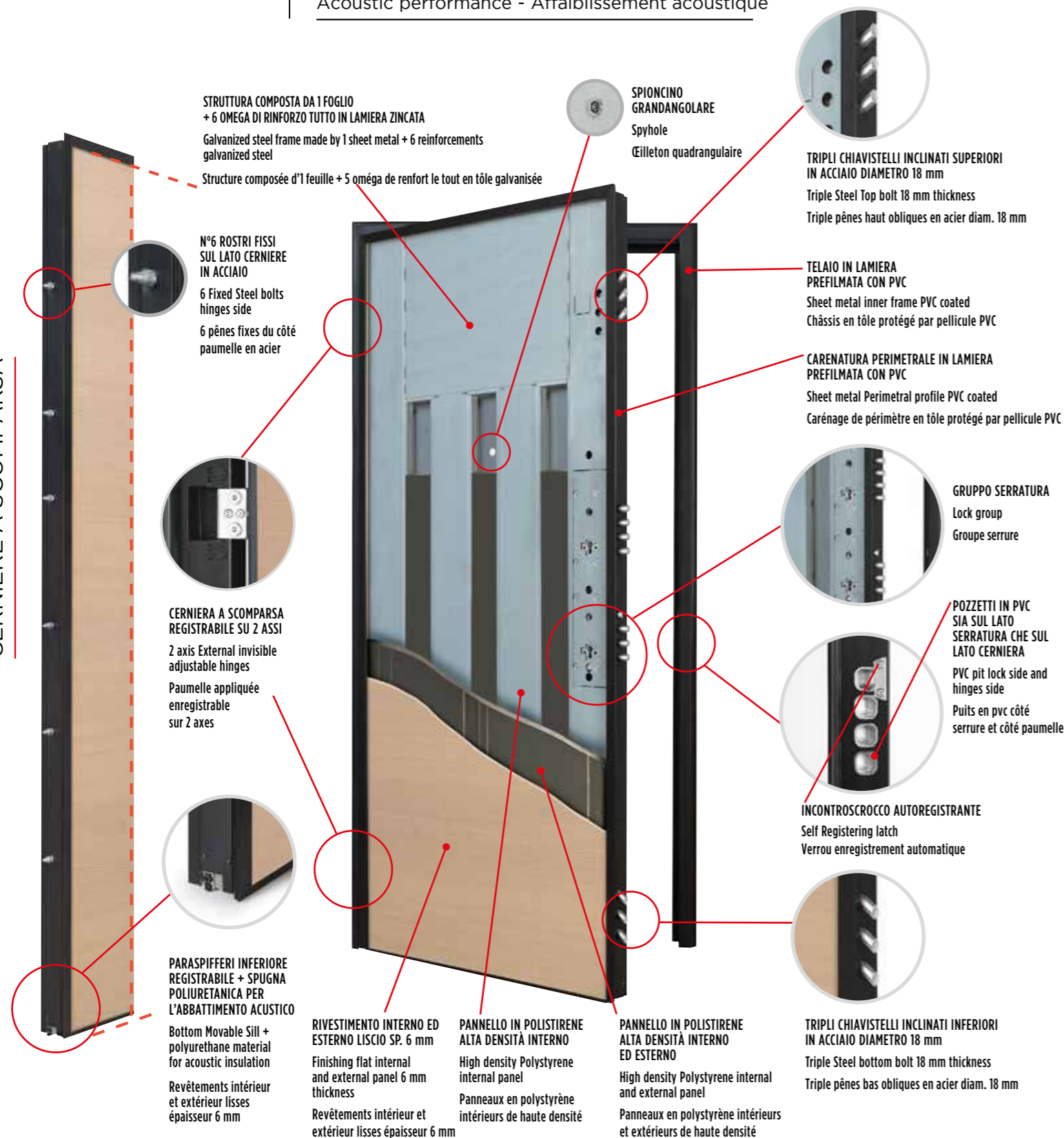

VERSIONI

Versions
Versions

Titanium CS



DOPPIO CILINDRO EUROPEO CON BLOCCO

Double European Cylinder profile with security lock

Cerradura con doble cilindro y bloqueo

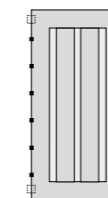

MISURE STANDARD

Standard Measures
Mesures standard

Larghezza / Width / Largeur:
cm 80 - 85 - 90

Altezza / Height / Hauteur:
cm 210

FUORI MISURA REALIZZABILI

Possible out of standard
Hors mesures réalisables

Larghezza / Width / Largeur:
da cm 50 a cm 110
from 50 cm to 110 cm
largeur de cm 50 à cm 110

Altezza / Height / Hauteur:
da cm 180 a cm 250
from 180 cm to 250 cm
hauteur de cm 180 à cm 250



SISTEMA BREVETTATO

Registered patented system
Système breveté

CERNIERA A SCOMPARSA ABSOLUTE
ABSOLUTE invisible hinge
Paumelle encastré Absolute

DOUBLE

CLASSE 3 di antieffrazione UNI-EN 1627
Anti Burglary - Résistance à l'effraction

TRASMITTANZA TERMICA - 1,4 W/(M².K)
Thermic conduction - Transmission thermique

ABBATTIMENTO ACUSTICO - 36 dB
Acoustic performance - Affaiblissement acoustique

STRUTTURA COMPOSTA DA 1 FOGLIO
+ 5 OMEGA DI RINFORZO TUTTO IN LAMIERA ZINCATA
Galvanized steel frame made by 1 sheet metal + 5 reinforcements
galvanized steel
Structure composée d'1 feuille + 5 oméga de renfort le tout en tôle galvanisée

N°6 ROSTRI FISSI
SUL LATO CERNIERE
IN ACCIAIO
6 Fixed Steel bolts
hinges side
6 pènes fixes du côté
paumelle en acier

CERNIERA A SCOMPARSA
REGISTRABILE SU 2 ASSI
2 axis External
invisible adjustable hinges
Paumelle appliquée
enregistrable
sur 2 axes

PARASPISFERI INFERIORE
REGISTRABILE + SPUGNA
POLIURETANICA PER
L'ABBATTIMENTO ACUSTICO
Bottom Movable Sill +
polyurethane material
for acoustic insulation
Revêtements intérieur
et extérieur lisses
épaisseur 6 mm

RIVESTIMENTO INTERNO ED
ESTERNO LISCIO SP. 6 mm
Finishing flat internal
and external panel 6 mm
thickness
Revêtements intérieur et
extérieur lisses épaisseur 6 mm

PANNELLO IN POLISTIRENE
ALTA DENSITÀ INTERNO
High density Polystyrene
internal panel
Panneaux en polystyrène
intérieurs de haute densité

PANNELLO IN POLISTIRENE
ALTA DENSITÀ INTERNO
ED ESTERNO
High density Polystyrene internal
and external panel
Panneaux en polystyrène intérieurs
et extérieurs de haute densité

SPIONCINO
GRANDANGOLARE
Spyhole
Œilleton quadrangulaire

N°6 ROSTRI FISSI
SUL LATO CERNIERE
IN ACCIAIO
6 Fixed Steel bolts
hinges side
6 pènes fixes du côté
paumelle en acier

GRUPPO SERRATURA
Lock group / Groupe serrure

Chiusa
Closed/Fermée

In apertura
Opening /
En ouverture

Aperta
Open/Ouverte

CARENATURA PERIMETRALE IN
LAMIERA PREFILMATA CON PVC
Sheet metal Perimetral profile
PVC coated
Carénage de périmètre en
tôle protégé par pellicule PVC

CHIAVISTELLO INFERIORE
IN ACCIAIO DIAMETRO 18 mm
Steel bottom bolt 18 mm
thickness
Pêne bas en acier diam 18 mm

CHIAVISTELLO SUPERIORE
IN ACCIAIO DIAM. 18 mm
Steel Top bolt 18 mm thickness
Pêne haut en acier diam 18 mm

TELAIO IN LAMIERA
PREFILMATA CON PVC
Sheet metal inner frame PVC coated
Châssis en tôle protégé par pellicule PVC

CERNIERE A SCOMPARSA

VERSIONI

Versions
Versions

Double R



DOPPIA MAPPA RICIFRABILE
(CAMBIO FACILE CISA)
Recordable Double bit
Double bit ré-chiffirable

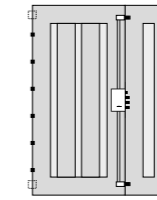

Double C



CILINDRO EUROPEO
European Cylinder profile
Cylindre européen

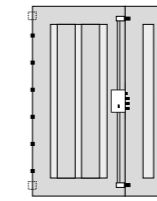

Optional Serratura CY e CS



CILINDRO EUROPEO
+ CILINDRO DI SERVIZIO
European Cylinder profile
+ Service cylinder
Cylindre européen
+ cylindre de service

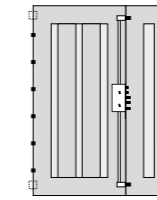

MISURE STANDARD

Standard Measures
Mesures standard

Larghezza asimmetrica / Asymmetrical width
Largeur asymétrique:
cm 80 - 85 - 90 + cm 30 - 35 - 40

Larghezza simmetrica / Symmetrical width
Largeur symétrique:
cm 50 - 60 - 65 + cm 50 - 60 - 65

Altezza / Height / Altura:
cm 210

FUORI MISURA REALIZZABILI

Possible out of standard
Hors mesures réalisables

Larghezza / Width / Largeur:
da cm 50 a cm 110
from 50 cm to 110 cm
desde 50 cm hasta 110 cm

Altezza / Height / Hauteur:
da cm 180 a cm 250
from 180 cm to 250 cm
desde 180 cm hasta 250 cm

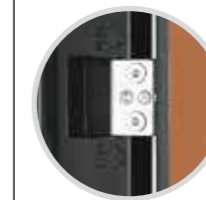

SISTEMA BREVETTATO Registered patented system Système breveté

CERNIERA A SCOMPARSA ABSOLUTE
ABSOLUTE invisible hinge
Paumelle encastré Absolute

CLASSE 3 di anti-effrazione UNI-EN 1627
Anti Burglary - Résistance à l'effraction

TRASMITTANZA TERMICA - 1,4 W/(M².K)
Thermic conduction - Transmission thermique

ABBATTIMENTO ACUSTICO - 34 dB
Acoustic performance - Affaiblissement acoustique

CERNIERE A VISTA

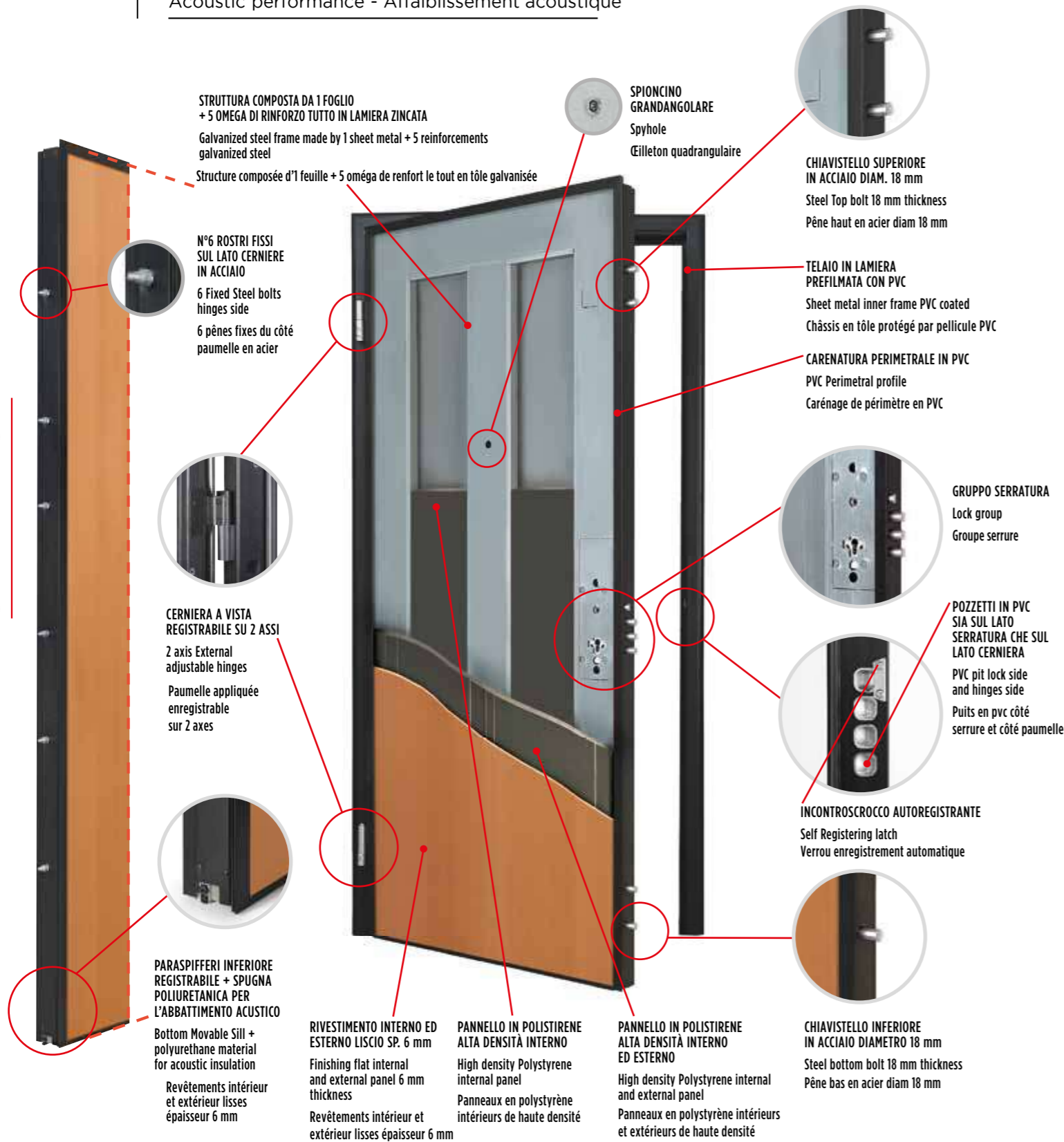

VERSIONI

Versions
Versions

ZTL C



CILINDRO EUROPEO
European Cylinder profile
Cylindre européen

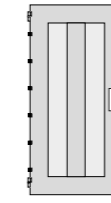

ZTL CS



DOPPIO CILINDRO EUROPEO CON BLOCCO
Double European Cylinder profile with security lock
Double cylindre européen avec blocage

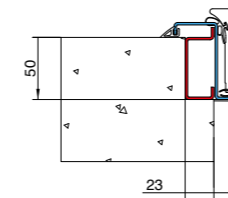
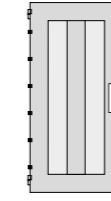

MONTAGGIO STANDARD
Standard set up
Montage standard

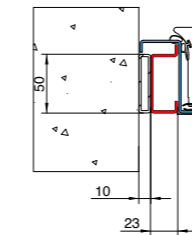

MONTAGGIO IN LUCE
Out side wall set up
Montage sur structure

MISURE STANDARD

Standard Measures
Medidas estandar

Larghezza / Width / Anchura:
cm 80 - 85 - 90

Altezza / Height / Altura:
cm 210

FUORI MISURA REALIZZABILI

Possible out of standard
Hors mesures réalisables

Larghezza / Width / Anchura:
da cm 50 a cm 110
from 50 cm to 110 cm
desde 50 cm hasta 110 cm

Altezza / Height / Altura:
da cm 180 a cm 250
from 180 cm to 250 cm
desde 180 cm hasta 250 cm

MAGMA 30

OMOLOGATA TAGLIA FUOCO EI2-30 secondo la norma EN 1634-1 - Certified Fireproof EI2-30 - Homologuée coupe-feu EI2-30 selon la norme EN 1634-1

TRASMITTANZA TERMICA - 2,0 W/(M².K)
Thermic conduction - Transmission thermique

ABBATTIMENTO ACUSTICO - 42 dB
Acoustic performance - Affaiblissement acoustique

Magma 30

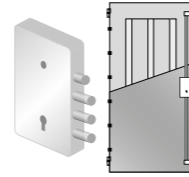

CILINDRO EUROPEO
European Cylinder profile
Cylindre Européen

CERNIERE A VISTA

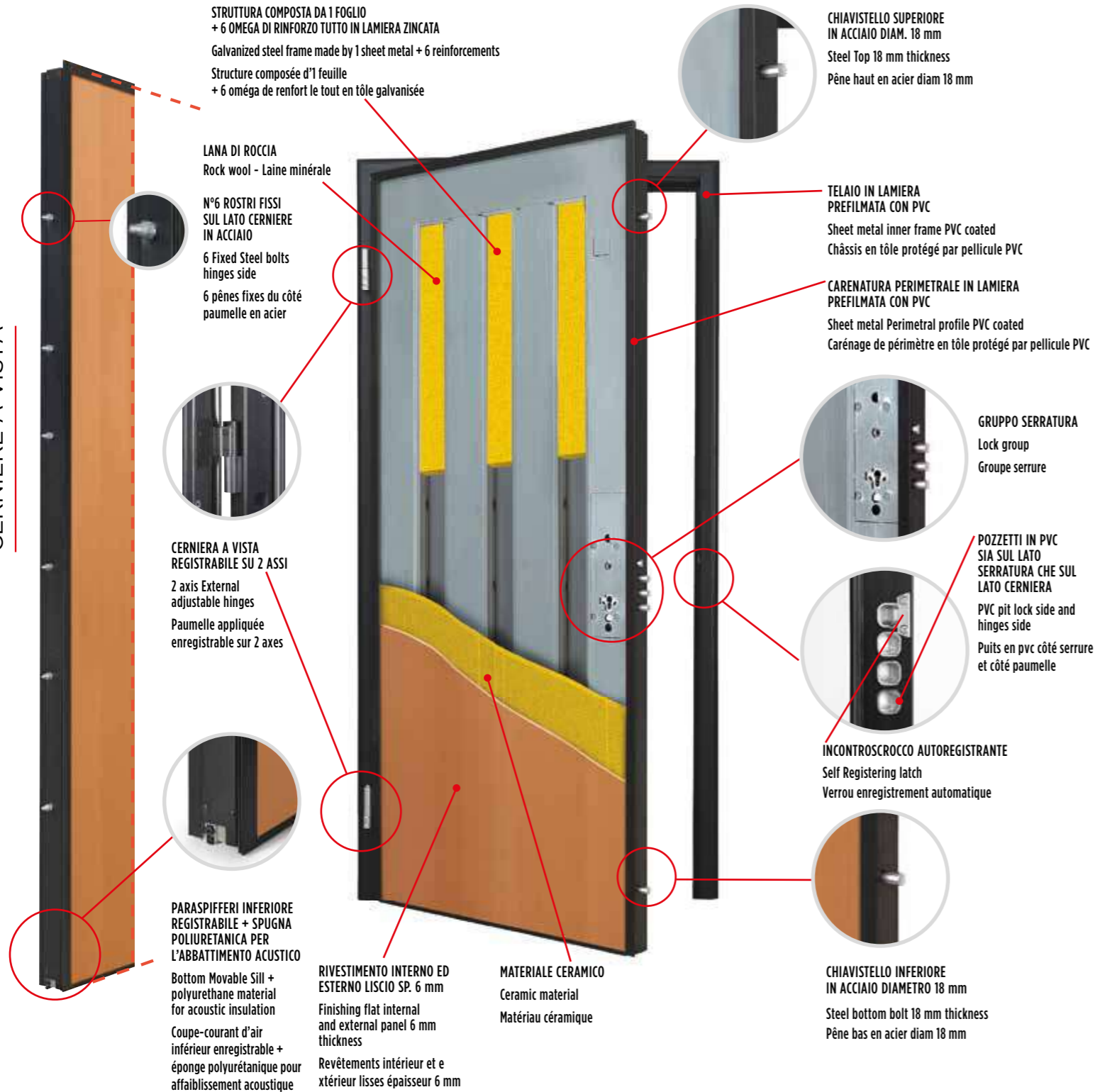

MAGMA 60

OMOLOGATA TAGLIA FUOCO EI2 60 secondo la norma EN 1634-1 - Certified Fireproof EI2 60 - Homologuée coupe-feu EI2 60 selon la norme EN 1634-1

TRASMITTANZA TERMICA - 2,0 W/(M².K)
Thermic conduction - Transmission thermique

ABBATTIMENTO ACUSTICO - 40 dB
Acoustic performance - Affaiblissement acoustique

Magma 60

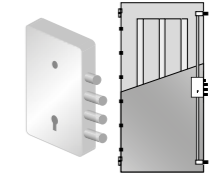

CILINDRO EUROPEO
European Cylinder profile
Cylindre Européen

CERNIERE A VISTA

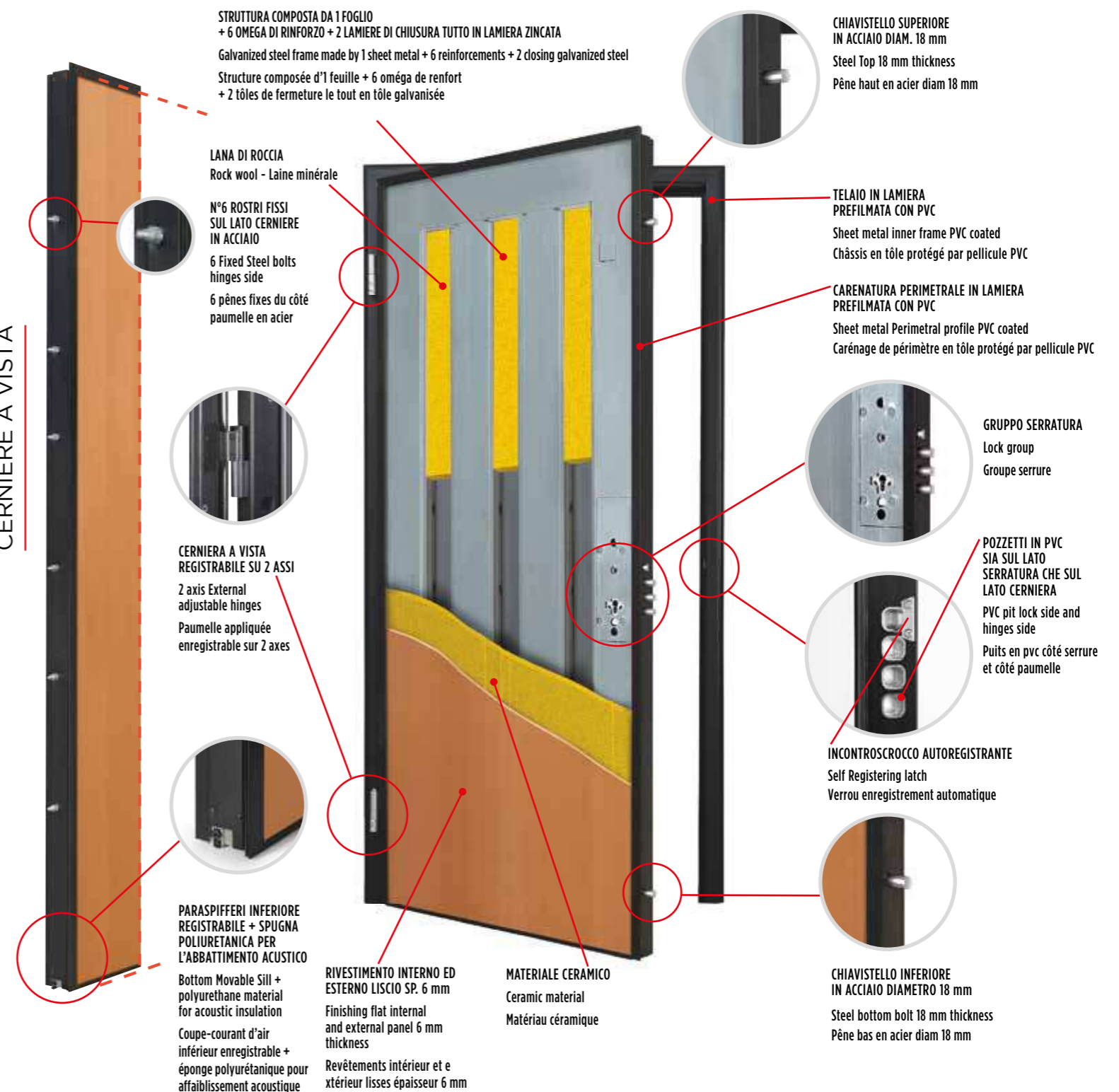

MAGMA 90

OMOLOGATA TAGLIA FUOCO EI2-90 secondo la norma EN 1634-1 - Certified Fireproof EI2-90
Homologuée coupe-feu EI2-90

TRASMITTANZA TERMICA - 2,0 W/(M².K)
Thermic conduction - Transmission thermique

ABBATTIMENTO ACUSTICO - 42dB
Acoustic performance - Affaiblissement acoustique

Magma 90

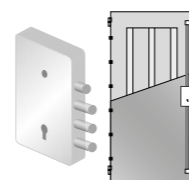

CILINDRO EUROPEO
European Cylinder profile
Cylindre Européen

VERSIONI

Versions
Versions

PUÒ MONTARE LA SERRATURA MOTORIZZATA CON O SENZA FUNZIONE ANTIPANICO
PUÒ MONTARE LA SERRATURA ELETTRICA (SOLO SCROCCO MOVIMENTATO)

It can install motorized lock (with or without panic lock)
It can install electric lock (only with moved latch)

Une serrure motorisée avec ou sans fonction anti-panique peut être montée
Une serrure électrique (seulement verrouiller) peut être montée

MISURE STANDARD VALIDE PER I MODELLI MAGMA 30-60-90

Standard Measures
Mesures standard

Larghezza / Width / Largeur:
cm 80 - 85 - 90

Altezza / Height / Hauteur:
cm 210

FUORI MISURA REALIZZABILI VALIDE PER I MODELLI MAGMA 30-60-90

Possible out of standard
Medidas no estandar que se pueden realizar

Larghezza / Width / Largeur:
da cm 80 a cm 103
from 80 cm to 103 cm
largeur de cm 80 à cm 103

Altezza / Height / Hauteur:
da cm 190 a cm 230
from 190 cm to 230 cm
hauteur de cm 190 à cm 230
Area fino a / Area up to / Superficie jusqu'à : 2.16 m²

CERNIERE A VISTA

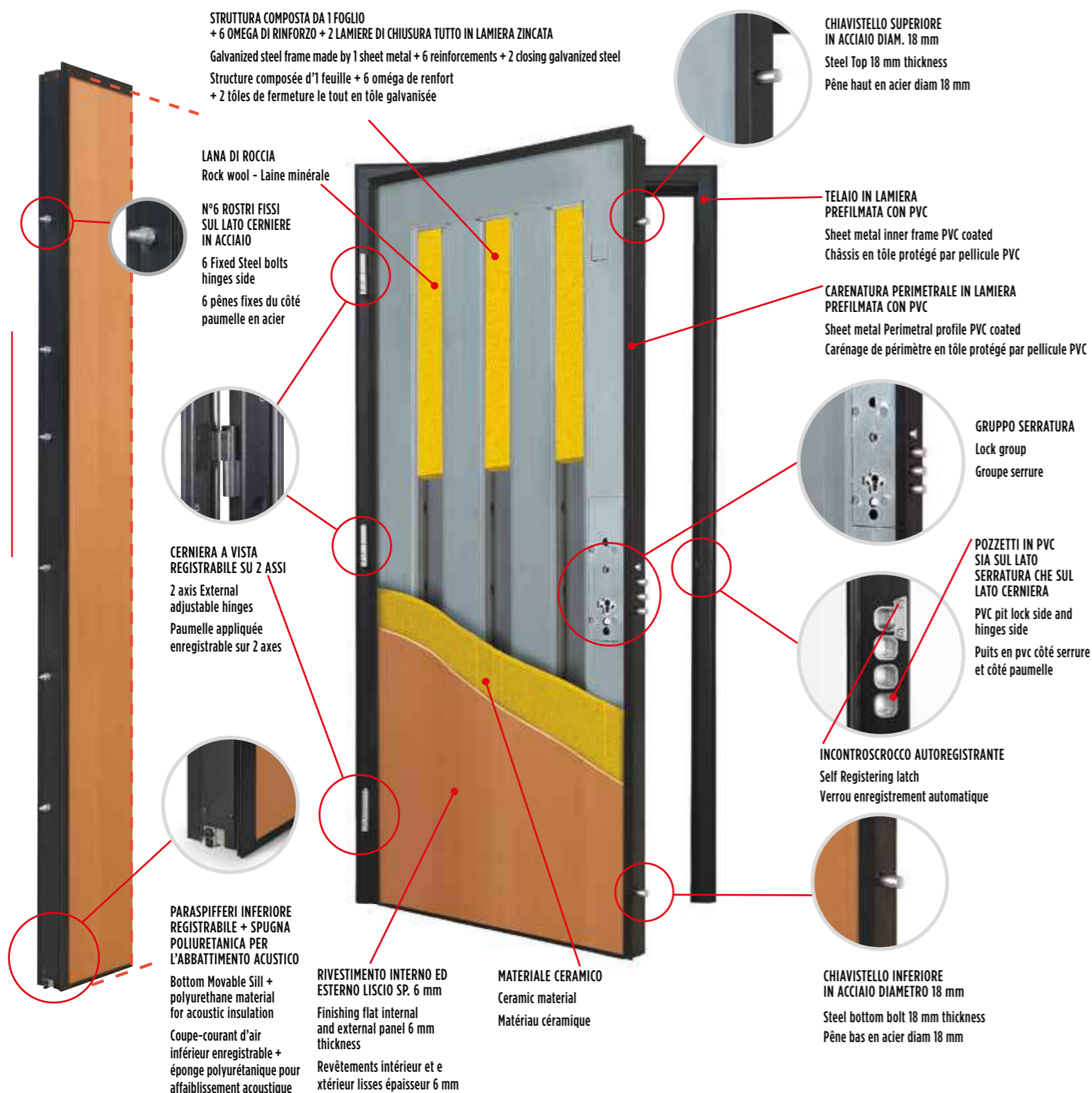

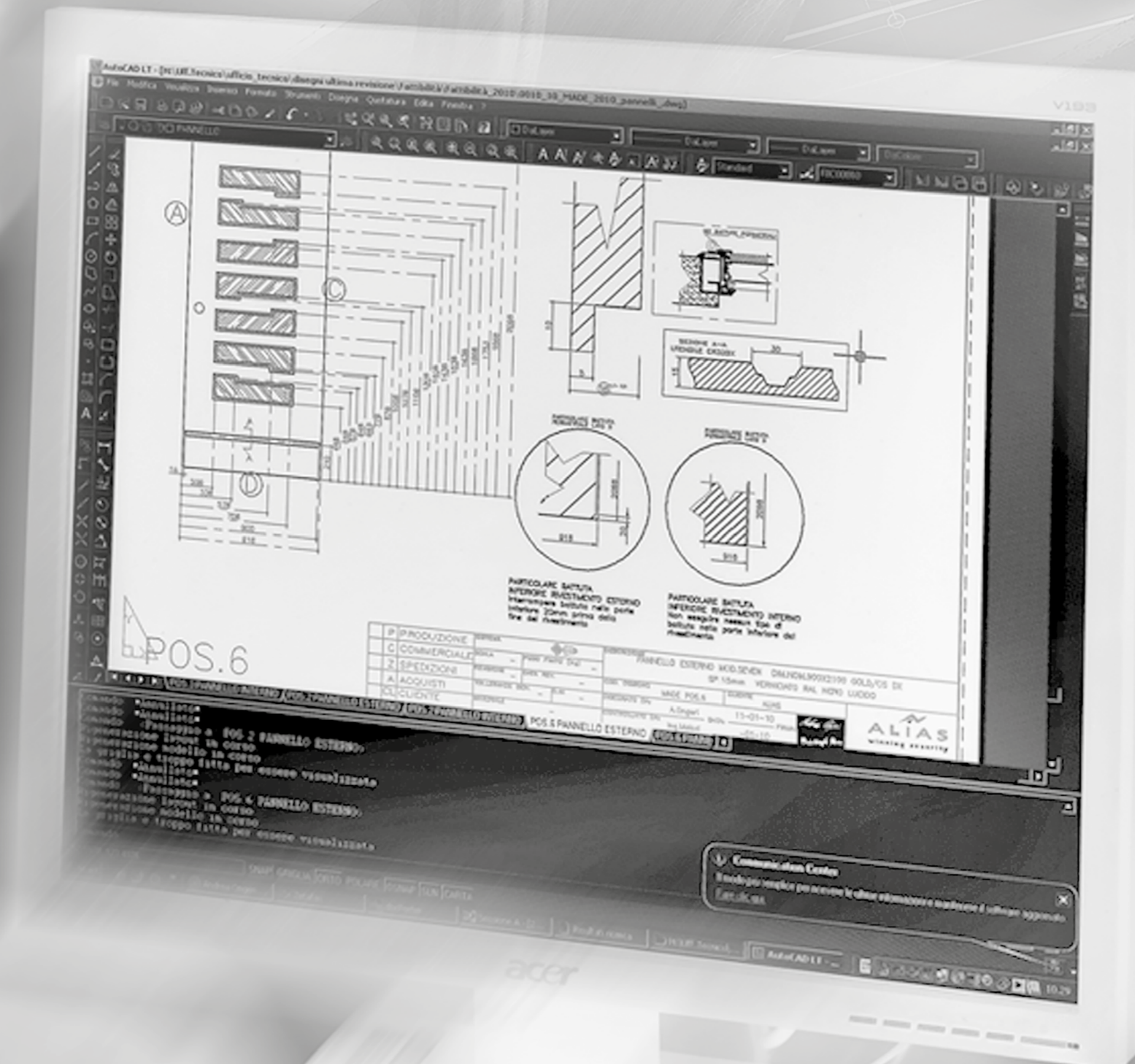

SOLUZIONI SPECIALI

SPECIAL SOLUTIONS
SOLUTIONS SPÉCIALES

ZTL CLASSE 3 - 1.4 W/(m²K)

UN PRODOTTO CHE NASCE PER SODDISFARE UN BISOGNO NELL'AMBITO DELLA RISTRUTTURAZIONE, SPESSO NEI CENTRI STORICI, DOVE GLI INGOMBRI SONO MINIMI ED E' NECESSARIO SOSTITUIRE LA PORTA ESISTENTE CON UN INTERVENTO POCO INVASIVO.

A product thought to satisfy the need in renovation, often in old towns, to reduce dimensions and avoid invasive intervention, in order to replace the existing door.

Un produit né pour satisfaire les besoins de rénovation, en grande partie dans les centres historiques, là où les encombrements doivent être minimes et là où il est nécessaire de remplacer une porte déjà existante par une intervention peu envahissante.

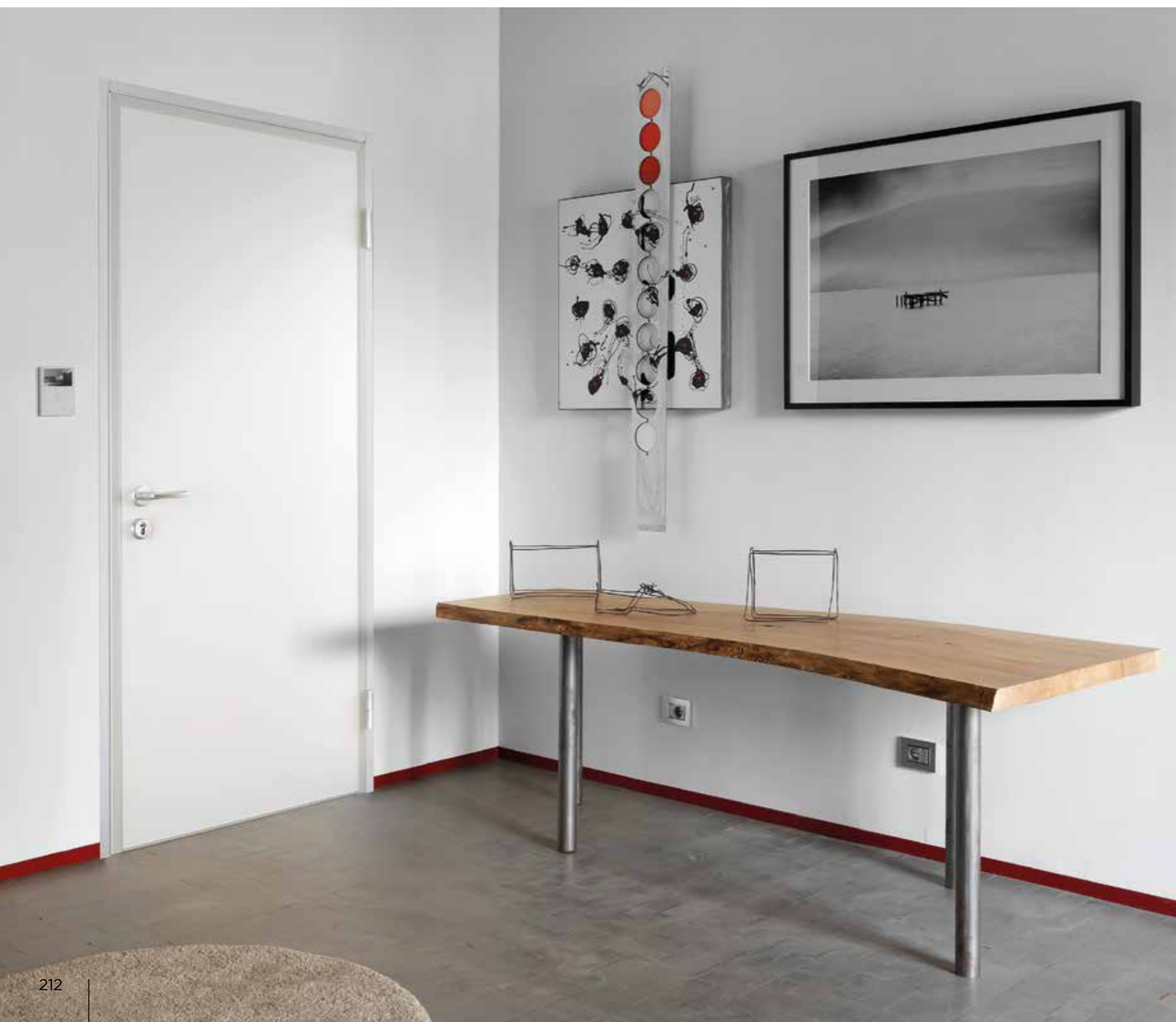

GRAZIE AD UNA SPECIALE CERNIERA DOTATA DI GRANO DI REGOLAZIONE ORIZZONTALE È POSSIBILE REGISTRARE L'ANTA ANCHE IN PROFONDITÀ OLTRE CHE IN ALTEZZA E LARGHEZZA.

Thanks to a special hinge provided with a specific screw for horizontal adjustment (M8?), it is possible to register the door not only in height and in width, but also in depth.

Grâce à une paumelle spéciale munie d'un grain de réglage horizontal, il est possible d'enregistrer les vantaux en hauteur, en largeur et même en profondeur.

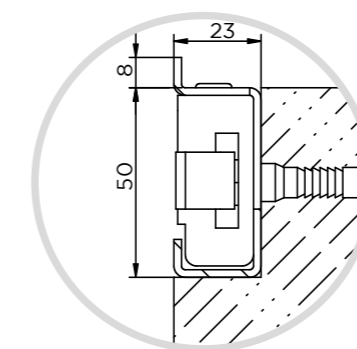

SISTEMA DI FISSAGGIO TRADIZIONALE CON LA MURATURA DEL CONTROTELAIO
Traditional fixing system with walled subframe
Système de fixation traditionnel à la maçonnerie de l' huisserie

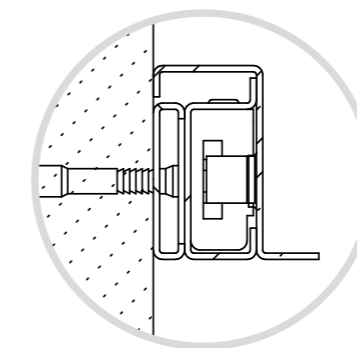

SISTEMA DI FISSAGGIO DEL TELAIO ACCOPPIATO AL CONTROTELAIO TRAMITE TASSELLO CHIMICO
Fixing system with the frame coupled to the subframe by chemical screw anchor
Système de fixation du bâti associé à l' huisserie à l'aide d'un élément chimique



IN AMBITO DI RISTRUTTURAZIONE PUÒ ESSERE IMPORTANTE RIVESTIRE ESTERNAMENTE LA PORTA ZTL CON PANNELLI IN LEGNO DELLA LINEA PRIMA CLASSE OPPURE DELLA LINEA URBAN CHE RICALCA PERFETTAMENTE LE GEOMETRIE DELLA PORTA SOSTITUITA PER UN INTERVENTO RISPETTOSO DEGLI ELEMENTI ESTETICI ESISTENTI.

In the field of restoration it could be useful to cover the ZTL door externally with Primaclasse or Urban collection wood panels, which perfectly reproduce the structure of the replaced door in order to operate in respect of the aesthetic elements already existing.

En ce qui concerne les rénovations, il peut être important de revêtir extérieurement la porte ZTL avec des panneaux en bois de la ligne Prima classe ou de la ligne Urban qui reproduisent parfaitement les géométries de la porte remplacée lors d'une intervention respectueuse des éléments esthétiques existants.

DUO BATTENTE

DUO (cerniera a vista) - (External fast joint hinges - Paumelle traditionnelle apparente)



DOUBLE (cerniera a scomparsa) - (Internal hinges - Charnières invisible)



LEVA PER PORTA A 2 ANTE

Lever for 2 leaves door

Levier pour porte à 2 vantaux



CHIUSA
Closed
Fermée

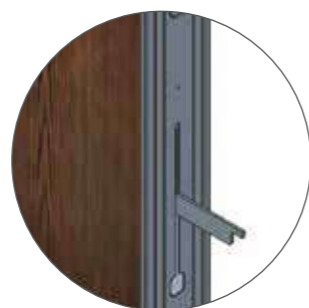

IN APERTURA
Opening
En ouverture



APERTA
Open
Ouvverte

SOLUZIONI DI RIVESTIMENTO INTERNO

Available solutions for internal panels

Solutions pour revêtement intérieur



PANNELLO INTERNO DA 6 MM A INCASSO DELLA CARENATURA

6 mm internal panel mounted inside leaf profile

Panneau intérieur de 6 mm encastré au carénage



PANNELLO INTERNO AVVOLGENTE A COPERTURA DELLA CARENATURA REALIZZABILE CON QUALSIASI RIVESTIMENTO DA 15 MM.

Internal panel that envelops and covers leaf profile, available with all 15mm thickness panels

Panneau intérieur appliqué au carénage réalisable pour tout revêtement de 15 mm

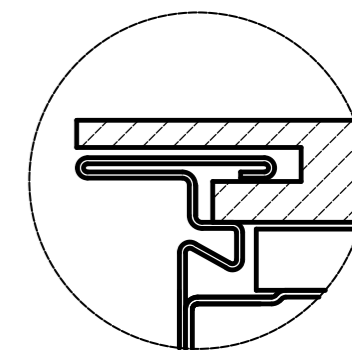

I PORTALI

Portales/Les chambranles

Grazie ad elementi decorativi aggiuntivi, le porte si trasformano in portali e stupiscono.
These decorative elements will turn your doors into portals. And everyone will be surprised.
Grâce à des éléments décoratifs supplémentaires, les portes se transforment et surprennent



ELEMENTI ARCHITETTONICI-DECORATIVI CHE NOBILITANO GLI INGRESSI ESTERNI TRASFORMANDOLI IN PROTAGONISTI ASSOLUTI DELLA SCENA. I PORTALI INCORONANO L'INGRESSO CON PANNELLATURE LATERALI E SUPERIORI REALIZZATE NEGLI STESSI MATERIALI E FINITURE DELLA PORTA E CREANO UN ATTRAENTE EFFETTO SCENOGRAFICO ESTERNO.

These architectural and decorative elements will put your entrance doors at centre stage. "GATE" PORTALS form a frame around the entrance door; the upper and side panels come in the same materials and finishes as the door, and the final effect is spectacular.

Les éléments architectoniques décoratifs embellissent les entrées extérieures et les mettent sur le devant de la scène. Les chambranles décorent l'entrée grâce à des panneaux latéraux et supérieurs réalisés dans les mêmes matériaux et les mêmes finitions que ceux de la porte en ce qui crée un effet des plus attrayants



L'AMPIA GAMMA, DENOMINATA "GATE", PERMETTE DI SODDISFARE TUTTI I TIPI DI ESIGENZE: ACCESSI BLINDATI DI GRANDI DIMENSIONI E DI SICURO IMPATTO ESTETICO PER PALAZZI STORICI, COSTRUZIONI CONTEMPORANEE, ABITAZIONI PRESTIGIOSE, ANTICHI CASALI, STUDI PROFESSIONALI. LA SICUREZZA SI VESTE DI STUPEFACENTE BELLEZZA.

The range is called "GATE", and has been designed to suit various needs, including large security doors with a strong visual impact for historic edifices, modern buildings, mansion houses, ancient farmhouses and offices. This is where security meets astonishing beauty.

La ligne "Gate" permet de satisfaire tous les besoins: les accès blindés de grandes dimensions assurent un impact esthétique aux édifices historiques, aux constructions contemporaines, aux villas prestigieuses, aux fermes anciennes, aux cabinets de groupe. La sécurité s'habille d'une incroyable beauté

FINISTRATURA

Glazing/Vitrages

Per tutti i modelli esclusi/For all models except

Pour tous les modèles sauf:

Magma 30, Magma 60, Magma 90

VETROCAMERA STANDARD PER ANTE FINESTRATE/ SOPRALUCE/FISSI VETRATI

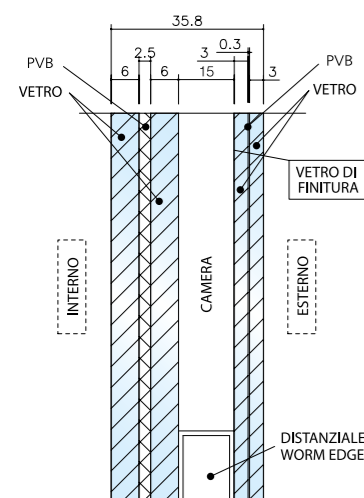

VETROCAMERA IN OPZIONE PER ANTE FINESTRATE

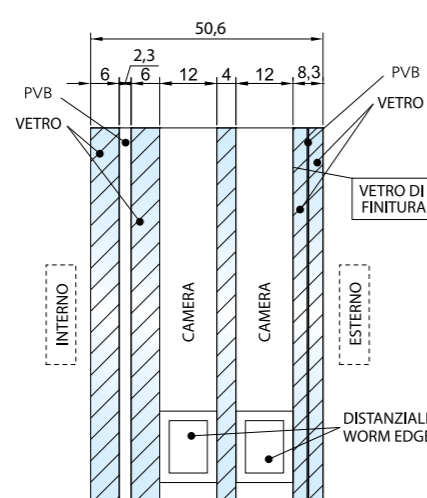

Stratobel 66.6 basso emissivo magnetronico -
12mm Argon 90% - 4mm Planibel clear -
12mm Argon 90% - Stratobel 33.1 trasparente



SULLE PORTE BLINDATE A VETRO ALIAS NON SONO PRESENTI CORNICI FERMA VETRO MA VENGONO PANTOGRAFATI I PANNELLI DI RIVESTIMENTO INTERNI ED ESTERNI IN MODO DA DETERMINARE LA SAGOMA DELLA FINISTRATURA. FRA IL VETRO E IL PANNELLO È PRESENTE UNA GUARNIZIONE ISOLANTE.

The ALIAS security doors with glass inlays do not feature glass securing frames but the inside and outside panels are pantograph-machined so as to determine the shape of the glass section. An insulation gasket is inserted between the glass and the panel.

Les portes blindées vitrées Alias ne comprennent pas de cadres de fixation de vitrage, elles sont en revanche dotées de panneaux de revêtement intérieurs et extérieurs pantographés de façon à déterminer la silhouette de l'ouverture. Un joint isolant est présent entre le vitrage et le panneau

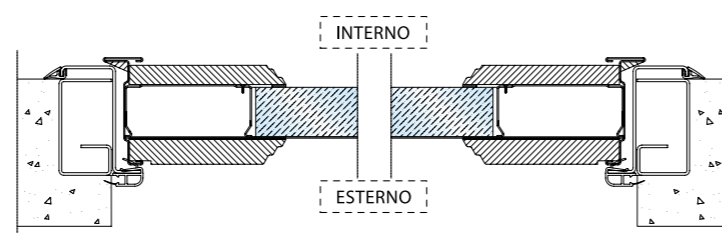

GRATA PER PORTA FINESTRATA

Glazed door grille

Grille pour porte vitrée



UN DESIGN, ORA TRADIZIONALE ORA INNOVATIVO, SEMPRE RAFFINATO, CHE SI COMBINA CON ESSENZE, COLORI E MATERIALI DIVERSI PER OFFRIRE UN'AMPIA SCELTA DI PORTE TRA LE QUALI TROVARE LA PIÙ ADATTA ALLO STILE E ALLA PERSONALITÀ DELLA TUA CASA.

LA GRATA È REALIZZATA DA UN UNICO FOGLIO DI ACCIAIO DELLO SPESSORE DI 4 MM TAGLIATO AL LASER, È QUINDI TOTALMENTE PRIVA DI ANTIESTETICI SEGNI DI SALDATURA.

LE LINEE, PULITE, SONO PERSONALIZZABILI SU DISEGNO.

A unique design, sometimes traditional, sometimes innovative, but always elegant, that combines with essences, colours and different materials in order to offer a wide range of doors among which you can find the one that most represents the style and personality of your home.

The door grille is made by a single, 4mm thick, laser cut, steel sheet and it does not present any kind of unaesthetic welding sign. Its lines are clean and they can be customized.

Le design, parfois traditionnel parfois innovant, mais toujours raffiné, s'accorde avec les essences, les couleurs et les différents matériaux pour offrir un ample choix de portes parmi lesquelles se trouve la plus apte au style et à la personnalité de votre habitat.

La grille est réalisée d'une seule feuille d'acier d'une épaisseur de 4 mm découpée au laser, elle est ensuite totalement privée de traces de soudure anti esthétiques.

Les lignes peaufinées peuvent être personnalisées sur dessin.

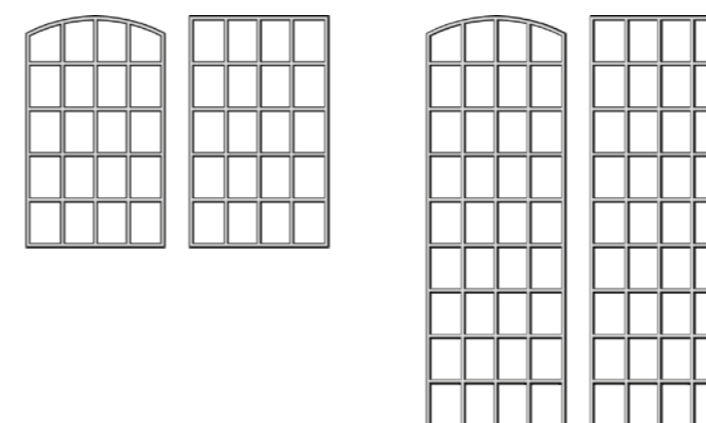
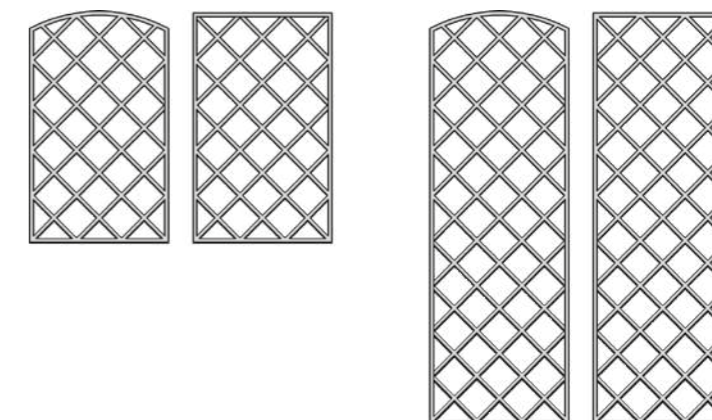

SOPRALUCE E FIANCHILUCE
Glass transom and side glass
Puits de lumière supérieur et puits de lumière latéraux



ALIAS PRODUCE CON LA CURA ARTIGIANALE DI UN ATELIER, PORTE FINESTRATE E CON SOPRALUCE A MISURA, RIVESTITE ALL'INTERNO DA LEGNO MASSICCIO

Glass doors and on demand transom glass, with internal solid wood panel produced with a craftsman care.

Alias produit avec le soin artisanal d'un atelier, des portes vitrées et à puits de lumière sur mesure, habillées de bois massif

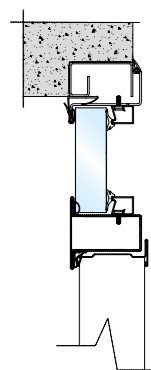

SEZIONE VERTICALE ANTA CON SOPRALUCE
 Vertical section of transom glass leaf
 Section verticale vantail à puits de lumière supérieur

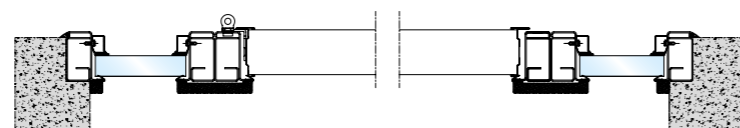

SEZIONE ORIZZONTALE ANTA CON DUE FIANCHI LUCE
 Horizontal section of a leaf with two side glasses
 Section horizontale vantail à deux puits de lumière latéraux

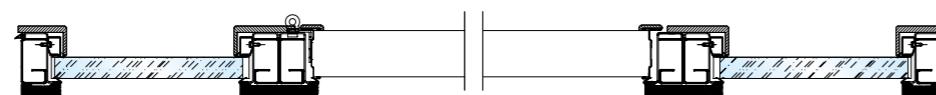

SEZIONE ORIZZONTALE ANTA CON DUE FIANCHI LUCE COMPLETA DEL KIT ATELIER PER INTERNO
 Horizontal section of the leaf with 2 side glass including Atelier Kit for inside
 Section horizontale vantail à deux puits de lumière latéraux complété par le kit atelier pour intérieur

SOPRALUCE
Glass transom
Puits de lumière supérieur

VASISTAS CON APERTURA MECCANICA O MOTORIZZATA. IL MOTORE È INTEGRATO, A SCOMPARSA, NEL TELAIO.

Mechanical or motorized opening wasidas, the engine is hidden and integrated in the frame.

Lucarne à ouverture mécanique ou motorisée. Le moteur est intégré, encastré dans le bâti.

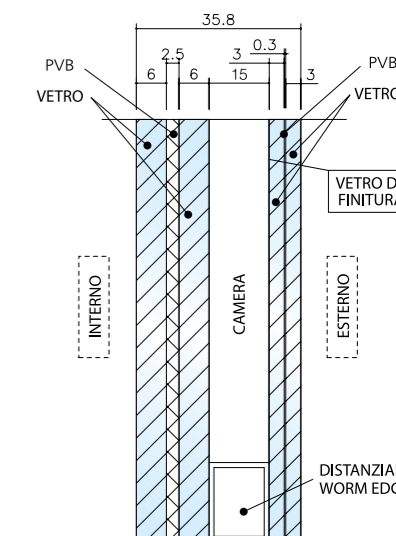

Stratobel 66.6 basso emissivo magnetronico - 15mm Argon 90% - Stratobel 33.1 trasparente





OPTIONAL

SERRATURA MOTORIZZATA

Motorized lock

Serrure motorisés



Lato esterno
External side
Côté externe



Lato interno
Internal side
Côté interne



ENTER

SEMPLICE E FUNZIONALE, ENTER È LA SERRATURA BASE PROPOSTA DA ALIAS. DOTATA DI PULSANTE INTERNO PER L'APERTURA DELLA PORTA, PREVEDE LA CHIUSURA AUTOMATICA DEI CATENACCI CON IL MERO ACCOSTAMENTO DELL'ANTA.

QUESTA SERRATURA, QUINDI, PERMETTE DI ENTRARE ED USCIRE AGEVOLMENTE DALLA PROPRIA ABITAZIONE SENZA L'UTILIZZO DELLA CHIAVE TRADIZIONALE (PUR SEMPRE UTILIZZABILE).

ESTERNAMENTE È DOTATA DI TASTIERA ALFANUMERICA. LA SUA ALIMENTAZIONE AVVIENE TRAMITE UNA BATTERIA O UN PASSACAVO COLLEGATO ALL'IMPIANTO ELETTRICO.

PREVEDE IL MONTAGGIO DI UNA MANIGLIA PASSANTE O UN POMOLO FISSO ESTERNO.

“Enter” is the simple and functional basic lock proposed by ALIAS. This type of lock is provided with an internal button that opens the door, besides when the leaf closes, the bolts are automatically extracted and the door is locked. This lock allows you to exit and enter your home easily without using the traditional key (that in any case can be used). In the external side, the lock is provided with an alphanumeric keyboard. The lock can be power supplied by batteries or wired to the home electric board. This lock allows to install the moving handle (both external and internal side) but also an external fixed knob.

Enter - Simple et fonctionnelle, Enter est la serrure base proposée par Alias. Dotée d'un bouton intérieur pour l'ouverture de la porte, elle prévoit la fermeture automatique des verrous par simple approche du vantail. Cette serrure permet, par conséquent, d'entrer et de sortir facilement de l'habitation sans devoir utiliser la clé traditionnelle (toutefois toujours utilisable). A l'extérieur, elle est dotée d'un clavier alphanumérique. Son alimentation se fait soit par batterie soit par câble relié à l'installation électrique. Elle prévoit le montage d'une poignée encastrée ou d'un pommeau extérieur fixe.



Lato esterno
External side
Côté externe



Lato interno
Internal side
Côté interne



EASY

E' LA SERRATURA DI FASCIA INTERMEDIA DI ALIAS. OLTRE A POSSEDERE TUTTE LE CARATTERISTICHE PROPRIE DELLA ENTER, QUINDI A ESSERE GOVERNATA DA UN SISTEMA ELETTRONICO AUTOMATICO CHE PERMETTE DI FARE A MENO DELLA CHIAVE TRADIZIONALE (PUR SEMPRE UTILIZZABILE), PREVEDE UNA TASTIERA ESTERNA CHE FUNGE ANCHE DA RICEVITORE PER IL TRANSPONDER, QUINDI CONSENTE L'APERTURA TRAMITE BADGE.

CON EASY È INOLTRE POSSIBILE CONFIGURARE 5 MODALITÀ DI PROGRAMMAZIONE DIVERSE.

PUÒ ESSERE ALIMENTATA TRAMITE BATTERIA O PASSACAVO COLLEGATO ALL'IMPIANTO ELETTRICO E MONTARE UNA MANIGLIA PASSANTE PIUTTOSTO CHE UN POMOLO FISSO ESTERNO.

It belongs to the intermediate category of locks by ALIAS. This lock has got not only all the characteristics of the “Enter” model, but also an automatic electronic system that allows you to do without the traditional key (that in any case can be used). It is provided with an external keyboard that works also as receiver for the transponder and that allows to open the door with the card. This lock allows you to configure 5 different programs. The lock can be power supplied by batteries or wired to the home electric board. Besides, this lock allows to install a moving handle (both external and internal side) but also an external fixed knob.

Easy est une serrure Alias de classe intermédiaire. Elle possède non seulement toutes les caractéristiques de Enter, c'est à dire une commande par système électronique automatique permettant de ne pas utiliser la clé traditionnelle (toutefois toujours utilisable), mais aussi un clavier extérieur servant de récepteur au transpondeur, ce qui consent l'ouverture par badge. Avec Easy, il est aussi possible de configurer 5 codes différents de programmation. Elle peut être alimentée par batterie ou par câble relié à l'installation électrique et permet de monter une poignée encastrée plutôt qu'un pommeau extérieur fixe.

SERRATURA MOTORIZZATA

Motorized lock

Serrure motorisée



SMART

TOP DI GAMMA DI ALIAS, LA SERRATURA SMART È GOVERNATA DA UN SOFISTICATO SISTEMA ELETTRONICO AUTOMATICO, CHE PERMETTE IL CONTROLLO DA REMOTO DEGLI ACCESSI DI CASA ATTRAVERSO IL PROPRIO SMARTPHONE.

BASTA SCARICARE L'APPOSITA APP GRATUITA, E IN POCHI SEMPLICI PASSAGGI SI POTRÀ AVERE IL TOTALE CONTROLLO DELL'INGRESSO DI CASA. SMART, INOLTRE, È CERTIFICATA PER LE PORTE TAGLIAFUOCO FINO A 90 MINUTI.

LA SUA ALIMENTAZIONE PUÒ AVVENIRE TRAMITE BATTERIA O TRAMITE PASSACAVO COLLEGATO ALL'IMPIANTO ELETTRICO OPPURE CON ENTRAMBI CONTEMPORANEAMENTE*.

NON È PREVISTA LA PULSANTIERIA INTERNA DI APERTURA IN QUANTO UTILIZZA UN SISTEMA ANTIPANICO IN GRADO DI PERMETTERE L'APERTURA AGENDO SEMPLICEMENTE SULLA MANIGLIA; OVVIAMENTE PREVEDE LA CHIUSURA AUTOMATICA DEI CATENACCI CON IL MERO ACCOSTAMENTO DELL'ANTA.

L'ELEGANTE TASTIERA ALFANUMERICA ESTERNA PUÒ ESSERE ABBINATA AD UN RICEVITORE A SCOMPARSA PER IL TRASPONDER, PREVEDENDO ANCHE L'APERTURA TRAMITE BADGE.

E' POSSIBILE CONFIGURARE 3 MODALITÀ DI PROGRAMMAZIONE .

* L'UTILIZZO DELLA TASTIERA CAPACITIVA ALIAS DEVE PREVEDERE OBBLIGATORIAMENTE L'ALIMENTAZIONE DA RETE ELETTRICA.

It represents the top of the locks by ALIAS. This model has got a sophisticated automatic electronic system that permits its remote control by means of your Smartphone. The only thing you have to do is download the APP, completely free, and in few simple steps you will have the total control of your house entryway.

Besides, "SMART" for fire doors is 90 minutes certified.

The lock can be power supplied by batteries or wired to the home electric board or both*. In this solution there is no internal button to open the door, but it uses an emergency lock system that allows to open the door simply by pushing the handle.

When the leaf closes, the bolts are automatically extracted and the door is locked.

The sophisticated alphanumeric keyboard can be combined with an hidden receiver for the transponder. The door can be opened also with the card. Besides, it is possible to configure the lock with 3 different programs.

*ALIAS CAPACITIVE KEYBOARD MUST BE USED WITH POWER SUPPLY.

Smart - Haut de gamme Alias, la serrure Smart est commandée par un système électronique automatique sophistiqué permettant de contrôler à distance les accès de l'habitat par smartphone.

Il suffit d'en télécharger l'App gratuite et en quelques simples passages, il est possible de contrôler l'entrée de l'habitat. En outre, Smart est certifié pour les portes coupe-feu jusqu'à 90 minutes.

Son alimentation est possible soit par batterie soit par câble relié à l'installation électrique soit par les deux en même temps.*

Une minuterie d'ouverture intérieure n'est pas prévue dans la mesure où le système anti panique permet l'ouverture par simple intervention sur la poignée; la fermeture automatique des verrous est naturellement prévue par simple approche du vantail.

L'élégant clavier alphanumérique extérieur peut être relié à un récepteur encastré pour le transpondeur, une ouverture est aussi prévue pour le badge.

Il est possible de configurer 3 codes de programmation.

*L'ALIMENTATION DU CLAVIER CAPACITIF ALIAS PRÉVOIT OBLIGATOIREMENT L'UTILISATION DU RÉSEAU ÉLECTRIQUE.



OPTIONAL LETTORE BIOMETRICO

Biometric reader

Lecteur biométrique en option

SISTEMI ELETTRONICI COMBINATI per una sicurezza a prova di click

PORTA BLINDATA D'INGRESSO DEL B&B CON SERRATURA MOTORIZZATA "SMART" E TASTIERA ALFANUMERICA



PORTE BLINDATE "DREAM" DI ACCESSO ALLE SINGOLE CAMERE CON CILINDRO ELETTRONICO "LIBRA SMART"

Room security doors with "LIBRA SMART" electronic cylinder

Portes blindées pour accéder aux chambres individuelles avec un cylindre électronique "LIBRA SMART"



DREAM - CLASSE 2 - 33 dB



"DREAM" - lato interno
Internal side - Côté interne

"Click-proof" combined electronic systems for a higher security

The B&B main entrance security door with motorized SMART lock with alphanumeric keyboard

Sistemi informativi combinati per una sicurezza très simple.

Porte de sécurité d'entrée pour un B&B avec serrure motorisée "Smart" et clavier numérique

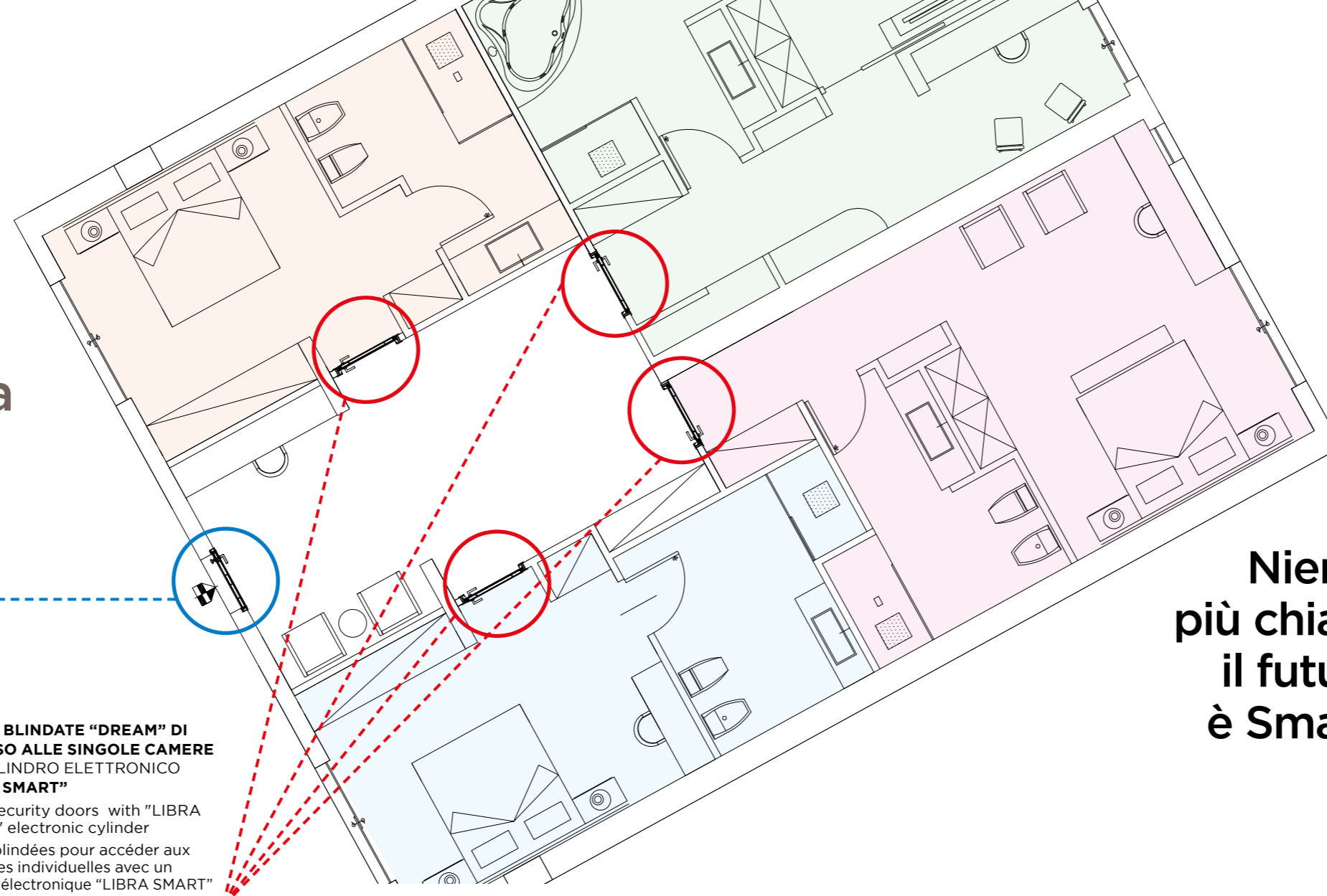

Niente più chiavi, il futuro è Smart!

No more keys, the future is Smart!

Alias proposes a complete and ideal solution for the access control for residential, light commercial (offices, small companies and shops) and Bed and Breakfast purposes. Nothing complex then, actually this system makes life easier, either for the owner and guests.

THE OWNER: he can remotely manage the locks of the main entrance security door as well as those of the DREAM doors for guest rooms, just by sending «the keys» with a simple message

THE GUEST: he can access the B&B and the rooms by unlocking the doors once close to them



Alias propone una soluzione completa e ideale per il controllo degli accessi in ambito residenziale, light commercial (uffici, piccole aziende, studi professionali e negozi) e Bed and Breakfast.

Nulla di complesso, anzi: si semplifica notevolmente la vita, sia del proprietario dell'immobile che degli ospiti.

IL PROPRIETARIO: può gestire **da remoto** le serrature sia della porta blindata d'ingresso Alias che delle porte interne "DREAM" delle varie stanze (sempre blindate e firmate Alias) e quindi inviare le "chiavi" ai suoi ospiti con un semplice messaggio.

L'OSPITE: può accedere all'immobile e alla/alle singole stanze, azionando le serrature una volta giunto **in prossimità** della porta.

Finies les clés, le futur est Smart!

Alias propose une solution complète pour contrôler les accès dans le domaine résidentiel, light commercial (bureaux, petites sociétés, bureaux d'étude et magasins) et Bed and Breakfast.

Rien de difficile, au contraire! La gestion est plus facile tant pour le propriétaire que pour les clients.

LE PROPRIÉTAIRE: il peut gérer a distance les serrures tant pour la porte blindée Alias que pour les portes «DREAM» (toujours blindées et signées par Alias) et donc envoyer les «clés» a ses clients avec un simple message.

LE CLIENT: il peut entrer dans sa chambre actionnant les serrures quand il est près de la porte.



Una sicurezza a prova di click che non ti farà più correre per consegnare/riprendere chiavi né ti farà preoccupare che possano essere smarrite/riprodotte senza la tua autorizzazione.

Check-in e check-out potranno avvenire in qualunque momento in tua assenza.

La gestione degli accessi non è mai stata così intuitiva: facilità d'uso e sicurezza sono state combinate in un modo totalmente nuovo, anticipando il futuro del controllo accessi.



Con il tuo smartphone e la Argo App di Iseo, infatti, puoi aprire e gestire gli accessi alla tua porta blindata Alias su cui è stata installata la serratura motorizzata **“SMART”** (Smartphone, carte, tag e codici PIN possono essere aggiunti o rimossi come credenziali di apertura, assegnando per ciascuna validità e turni orari).

Puoi inoltre utilizzare la stessa app per controllare il cilindro elettronico **“LIBRA SMART”** installato, ad esempio, sulle porte interne Dream.



By using your smartphone and the Argo App by Iseo, you can in fact manage the accesses of your Alias security door equipped with the «SMART» motorized lock (smartphone, badges, tag and PIN codes can be added or removed from the list of opening devices and can be validated on a time shift basis). The same app can control the electronic cylinder «LIBRA SMART» installed, for example, on internal DREAM security doors.

A “click-proof” safety that will allow you not to worry about the keys anymore, neither to pick them up nor to worry about the chance that unauthorized persons could duplicate them. Check-in and check-out could be done at any time, even in your absence.

The access management is really intuitive: ease of use and safety anticipate the future of access control

Avec ton smartphone et la App Iseo Argo tu peux ouvrir et gérer les accès à ta porte blindée Alias avec serrure «SMART» (Smartphone, cartes, tag et codes PIN peuvent être ajoutés ou retirés comme références d'ouverture, en attribuant pour chacune validité et horaires). Tu peux utiliser la même app pour contrôler le cylindre électronique «LIBRA SMART» installé, par exemple, sur les portes internes Dream.

Une sécurité très simple que t'aide à être plus tranquille, sans courir pour livrer/reprenre les clés et sans la peur que quelqu'un puisse les reproduire sans ta autorisation.

Il sera possible de faire le check-in et le check-out n'importe quel moment même en ton absence.

La gestion des accès n'a jamais été tant simple: facilité d'emploi et sécurité ont été associés d'une façon neuve, en anticipant le futur du control des accès.

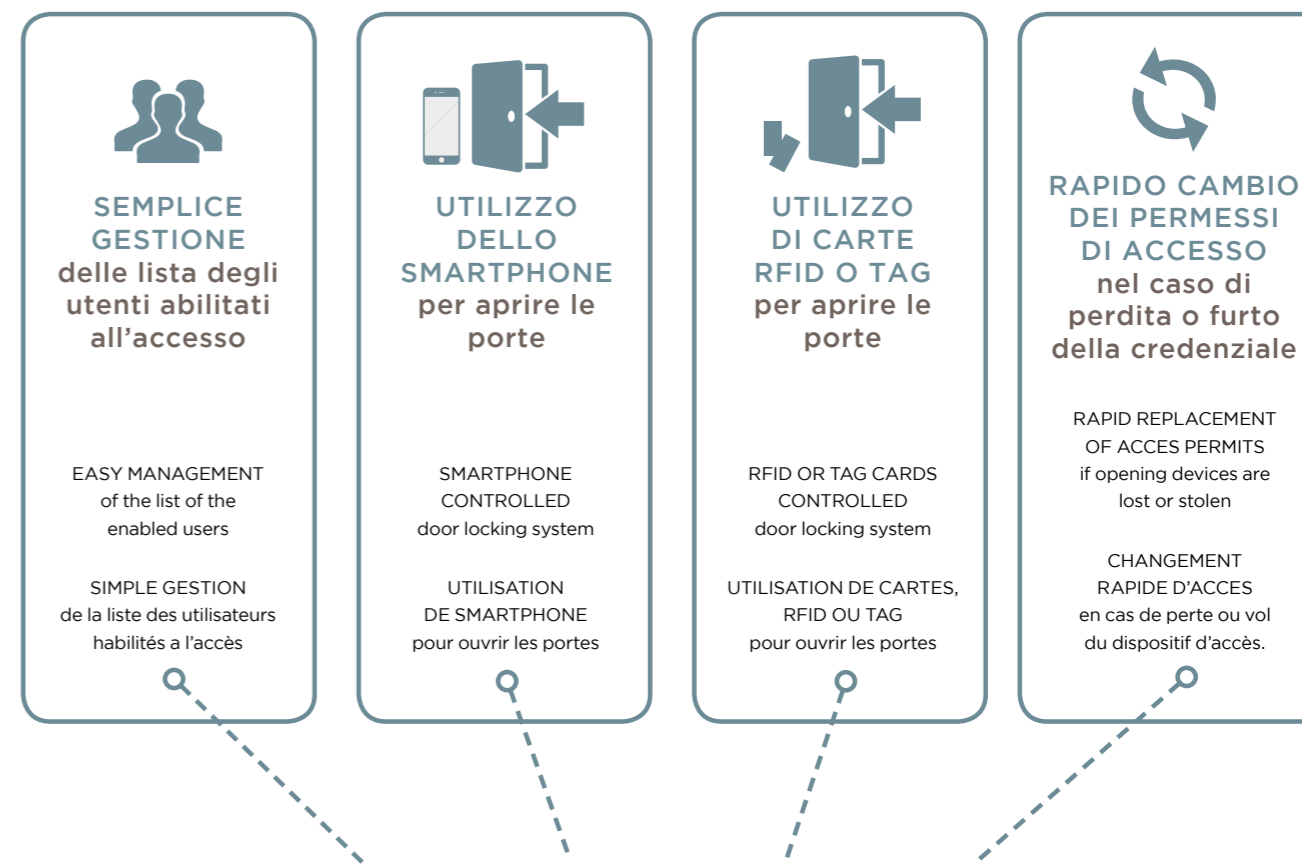

CARATTERISTICHE PRINCIPALI MAIN FEATURES - CARACTERISTIQUES PRINCIPALES

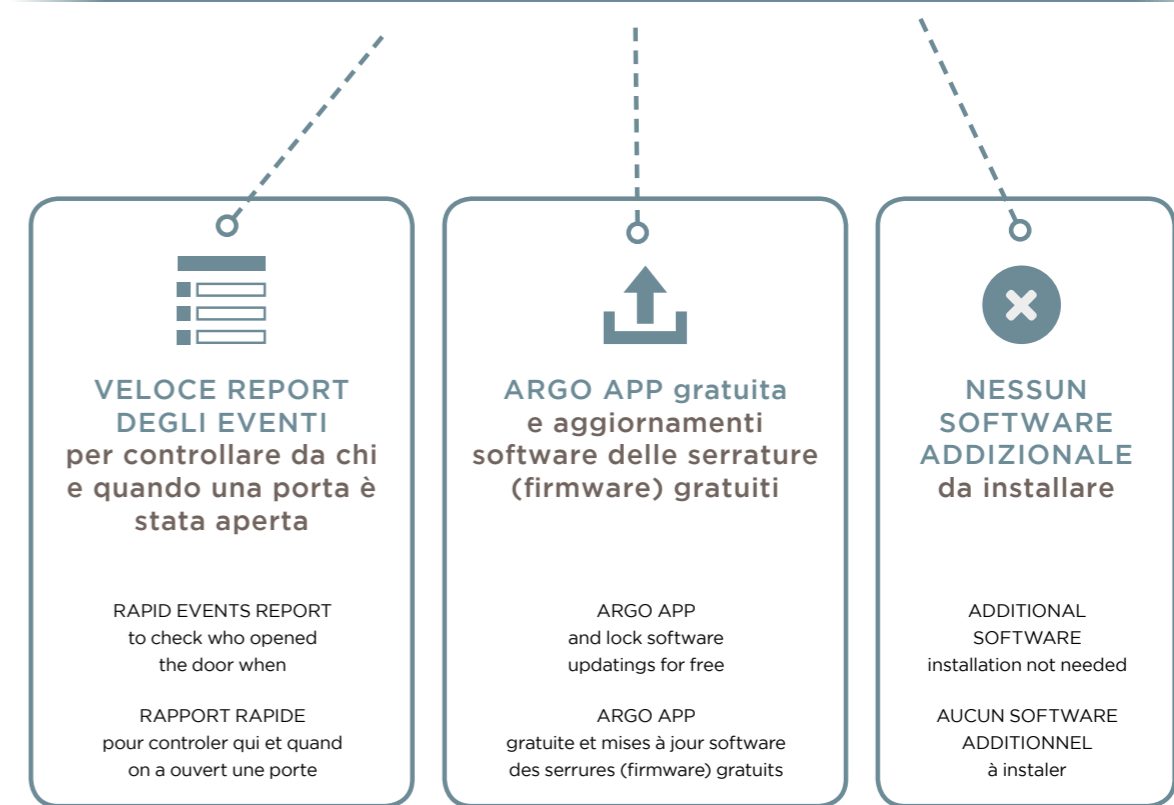

ISEO Argo



Semplicemente installando Argo App su uno smartphone iOS o Android, puoi gestire, controllare e aprire tutte le serrature ISEO della serie Smart, senza la necessità di software aggiuntivo o connessione ad internet. Tutto ciò grazie alla tecnologia Bluetooth Smart, che permette allo smartphone di comunicare con le serrature ISEO Smart. Con Argo, puoi organizzare i permessi di accesso di 300 utenti per porta e vedere gli ultimi 1000 eventi (entrate, tentativi di accesso non autorizzati, etc.) In aggiunta allo smartphone, le porte possono essere aperte usando carte ISEO e carte RFID già esistenti sull'impianto (carte di credito contactless, biglietti di trasporti pubblici, carte di altri controlli di accesso, etc.) ARGO è per te semplicità, controllo di accesso e tranquillità.

ISEO Argo

Simply by getting Argo App on a iOS or Android Smartphone, you can manage, monitor and open all ISEO locks of the SMART series, without an additional software or internet connection. All of that is thanks to the Bluetooth Smart technology, that connects the smartphone to ISEO Smart locks. ARGO App. allows you to organize access permits for 300 users per each door and to see the last 1000 events (entries, unauthorized accesses, etc). Besides the smartphone, doors can be opened with ISEO and RFID cards already installed on the device (contactless credit cards, tickets for public transports, other access control cards, etc.). ARGO is simplicity, access control and tranquility.

ISEO Argo

On peut gérer, contrôler et ouvrir toutes les serrures ISEO de la gamme Smart en installant Argo App sur un smartphone iOS ou Android sans aucun logiciel additionnel ou connexion internet. Cela est possible grâce à la technologie Bluetooth Smart, qui permet au smartphone de communiquer avec les serrures ISEO Smart. Avec Argo on peut organiser les autorisations d'accès de 300 utilisateurs pour chaque porte et voir les derniers 1000 mouvements (entrées ou essais d'entrée non autorisés). On peut ouvrir les portes aussi avec cartes ISEO et cartes RFID qui existent déjà sur le système (carte de crédit contactless, billets de transports publics, cartes des autres contrôles d'accès etc.). ARGO est pour toi simplicité et tranquillité.

I Dispositivi

Grazie alla tecnologia Bluetooth Smart, puoi aprire la porta con il tuo smartphone. L'appArgo gratuita permette ad ogni smartphone Bluetooth SmartReady (iOS, Android) di aprire le porte su cui è installata una serratura ISEO della serie Smart (Libra Smart, Aries Smart, x1R Smart, Stylos Smart, Smart Locker). La tecnologia Bluetooth Smart permette l'apertura da remoto della porta fino ad una distanza di 10 metri. Puoi quindi utilizzare il tuo smartphone anche come telecomando per aprire la tua porta.



The Devices

Thanks to the Bluetooth Smart technology you can easily open the door by using your smartphone. The free ARGO App. allows every SmartReady Bluetooth smartphone (iOS, Android) to open doors equipped with ISEO SMART locks (Libra Smart, Aries Smart, x1R Smart, Stylos Smart, Smart Locker). The Bluetooth Smart technology allows the remote opening of the door from a distance of a maximum of 10 metres. You can therefore use your smartphone as a remote control

Les Dispositifs

Grâce à la technologie Bluetooth Smart tu peux ouvrir la porte avec ton smartphone. App Argo gratuite permet à chaque smartphone Bluetooth SmartReady (iOS, Android) d'ouvrir les portes avec une serrure ISEO de la gamme Smart (Libra Smart, Aries Smart, X1R Smart, Stylos Smart, Smart Locker). La technologie Bluetooth Smart permet l'ouverture à distance jusqu'à 10 mètres. On peut donc utiliser le smartphone comme télécommande pour ouvrir la porte.

APERTURA con codici pin

PUOI ANCHE APRIRE LA SERRATURA SMART CON UN PIN CODE DA 4 A 14 CIFRE USANDO LA TASTIERA ALIAS TOUCH.



OPENING by pin codes

You can also open the Smart lock by using a PIN CODE from 4 to 14 digits by using the ALIAS TOUCH keyboard

OUVERTURE avec codes Pin

Tu peux ouvrir la serrure smart avec un pin code de 4 a 14 chiffres en utilisant le clavier Alias touch

APERTURA con carte o tags

LE CARTE ISEO POSSONO ESSERE USATE COME CHIAVE DELLA TUA PORTA. SEMPLICEMENTE, PRESENTA LA CREDENZIALE POCHI CENTIMETRI VICINO AL LETTORE E LA PORTA SI APRIRÀ.



OPENING by cards or tags

ISEO cards can be used as door keys. The door will open simply by approaching the card some centimeters to the reader.

OUVERTURE avec cartes ou tags

Les cartes iseo sont utilisées comme clés pour ta porte. Il faut simplement rapprocher les cartes au lecteur et la porte s'ouvrira'

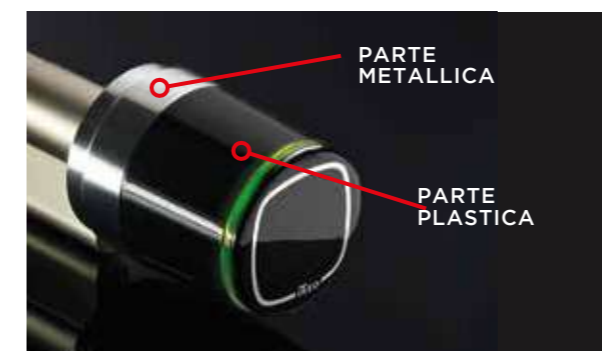

Finiture disponibili: Available finishings: /Finitions possibles

PARTE PLASTICA NERO LUCIDO (abbinabile a parte metallica inox o cromo lucido)

SHINY BLACK PLASTIC ITEM
(to be combined with stainless steel or shiny chrome metallic item)

PARTIE PLASTIQUE NOIR BRILLANT
(couplé a partie métallique inox ou chromé brillant)

PARTE PLASTICA BIANCO LUCIDO (abbinabile a parte metallica cromo satinato)

SHINY WHITE PLASTIC ITEM
(to be combined with matt chrome metallic item)

PARTIE PLASTIQUE BLANC BRILLANT
(couplé a partie métallique chromé satiné)

Il cilindro elettronico "LIBRA SMART" può essere facilmente installato sulla porta blindata per interni Dream; ha una funzione elettromeccanica, cioè si sblocca elettronicamente per poi essere azionato in apertura manuale.

"Dream" e "Libra" sono un binomio ideale in contesti alberghieri o Bed and Breakfast. È un prodotto certificato ai più alti livelli delle certificazioni di sicurezza internazionali. È l'unico cilindro al mondo ad aver raggiunto il grado IP66, IP67, IP69.

The "LIBRA SMART" electronic cylinder can be easily installed on the DREAM internal security door; it has an electromechanical function which means that can be electronically unlocked by approaching the card and actioned then manually to open the door.

"Dream" and "Libra" are the ideal combination for hotels and Bed and Breakfast. They gained the higher international Safety Certificate. It's the only one in the world which reached the level IP6, IP67 and IP 69.

On peut installer le cylindre électronique «LIBRA SMART» aussi sur les portes blindées Dream; il a une fonction électromécanique, c'est à dire en rapprochant la carte il se débloque électroniquement mais il est actionné manuellement pour l'ouverture.

«Dream» et «Libra» sont un ensemble parfait pour hotel ou B&B. C'est un produit qui est certifié selon les plus hautes certifications internationales. C'est le seul cylindre au monde qui a obtenu le degré IP66, IP67, IP69..

FINITURA TELAI E PROFILI PERIMETRALI

Frames finishing and perimetral profiles

Finitions des bâtis et des profilés de périmètre

È POSSIBILE SCEGLIERE LA FINITURA DEL TELAIO E DEL PROFILO PERIMETRALE DELLA PORTA FRA I SEGUENTI COLORI :

It is possible to choose the frame finishings and perimetral profiles among the following colours:

Il est possible de choisir la finition du bâti et du profilé de périmètre de la porte parmi les couleurs suivantes:



ABBINANDO AI RIVESTIMENTI INTERNI IN LEGNO LE NOSTRE FINITURE ROVERE - WENGÉ - MOGANO - NOCE È POSSIBILE OTTENERE UN EFFETTO DI TOTALE UNIFORMITÀ E PREGIO.

By matching the internal wood door with our OAK - WENGÉ - MAHOGANY - WALNUT finishes, it is possible to achieve an effect of complete uniformity and quality.

En associant nos finitions chêne, wengé, acajou, noyer aux revêtements intérieurs en bois, il est possible d'obtenir un effet de parfaite uniformité et de qualité.



TINTE LEGNO

Wood colours
Couleurs de bois

UTILIZZANDO L'ALLUMINIO SI POSSONO OTTENERE ABBINAMENTI DALLO STILE DECISAMENTE PIÙ CONTEMPORANEO SIA CON I RIVESTIMENTI IN LEGNO CHE CON QUELLI LACCATI.

The use of aluminium enables to create combinations with a decidedly more contemporary style for both wood and lacquered finishing.

L'utilisation d'aluminium avec revêtements en bois et revêtements laqués permet d'obtenir des combinaisons de style beaucoup plus contemporaines.



ALLUMINIO

Aluminium
Aluminium

È CONSIGLIATO CON QUESTA SOLUZIONE L'ABBINAMENTO DEI RIVESTIMENTI INTERNI ED ESTERNI DEL MEDESIMO BIANCO. SE NON FOSSE POSSIBILE RISPETTARE QUEST'OSSERVANZA È DISPONIBILE UNA GUARNIZIONE NERA CHE RIVESTE IL PROFILO PERIMETRALE ALL'ESTERNO DELL'ANTA IN MODO CHE NON SIA VISIBILE IL COLORE BIANCO QUANDO LA PORTA SI TROVA CHIUSA.

This solution is recommended to finish the internal and external door panels with the same colour. If this is not possible, a black strip can be applied along the outer profile so that the white colour cannot be seen when the door is closed.

Cette solution conseille le choix du blanc pour les revêtements intérieurs et extérieurs. Autrement, une finition noire revêtant le profilé de périmètre extérieur rendra la couleur blanche invisible quand la porte est fermée.



BIANCO

White
Blanc



GUARNIZIONE PER CARENA BICOLORE

Two coloured strip
Garniture pour
carénage bicolore

PER UNA RESA ESTETICA MIGLIORE LA FINITURA DEL TELAIO E DEL PROFILO PERIMETRALE DELLA PORTA BRUNITECH, PUO' ESSERE ABBINATA ALLA MANIGLIERIA. IN QUESTE IMMAGINI ALCUNI ESEMPI.

For better aesthetic results, it is possible to combine the brunitech finishing of the door frame and perimetral profile with the handels, as shown in the photos.

Pour un meilleur résultat esthétique, la finition du bâti et du profilé de périmètre de la porte Brunitech, peut être combinée aux poignées. Quelques exemples sont donnés dans ces photos.



Brunitech



CONTROTELAI Secondary frames Huisseries

ALIAS HA UN CONTROTELAIO STANDARD CHE UNA VOLTA MURATO A REGOLA D'ARTE PUÒ ACCOGLIERE TUTTE LE TIPOLOGIE DI PORTE, SIA QUELLE CON CERNIERA A VISTA CHE QUELLE CON CERNIERA A SCOMPARSA. TUTTAVIA È POSSIBILE, PER ESIGENZE DI POSA, SCEGLIERE ALTRE TIPOLOGIE DI CONTROTELAIO QUI A FIANCO INDICATE.

ALIAS has a standard secondary frame that after being perfectly embedded in the wall can house any type of door, with external or invisible hinges. However, should the door installation require it, it is possible to choose further types of secondary frames as shown on the right.

Alias a une huisserie standard qui, une fois murée selon les règles, peut recevoir toutes les typologies de portes, portes à paumelles en applique et portes à paumelles encastrées. Il est toutefois possible, pour différentes raisons, de choisir d'autres typologies d'huisserie indiquées ici, à droite.

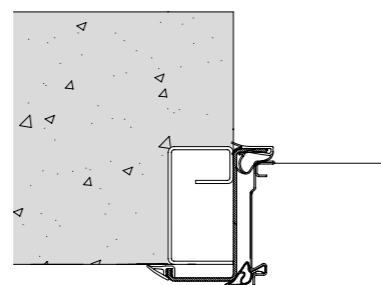

CONTROTELAIO STANDARD

Standard secondary frame
Huisserie standard

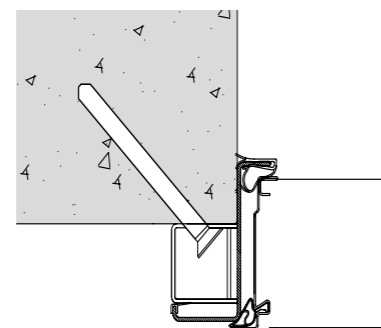

CONTROTELAIO FRANCESE

French secondary frame
Huisserie française

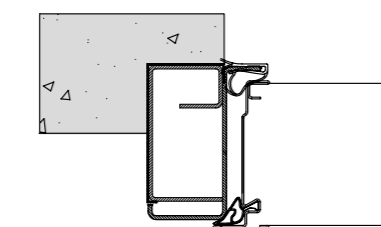

CONTROTELAIO GENOVESE

Genoese secondary frame
Huisserie génoise

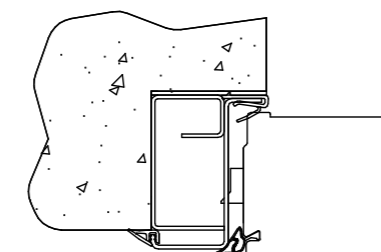

CONTROTELAIO FILO INTONACO

Counter frame flush with the wall
Huisserie raz du contre-bati

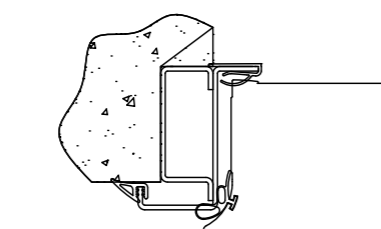

CONTROTELAIO PER PORTA ZTL

ZTL secondary frame
Huisserie pour porte ZTL

VISION - VISORE DIGITALE

Vision Digital viewer
Vision - Œilleton électronique

IL NUOVO SISTEMA ELETTRONICO CON VISORE DIGITALE SCELTO DA ALIAS PER SOSTITUIRE LO SPIONCINO TRADIZIONALE OTTENENDO UNA VISIONE CHIARA DI ALTA QUALITÀ. PERCHÉ UTILIZZARE IL VISORE DIGITALE? PERCHÉ POSSIAMO NOTARE I BENEFICI DI UN'IMMAGINE CHIARA E INGRANDITA. CON LO SPIONCINO TRADIZIONALE L'IMMAGINE È POVERA, LE PERSONE ANZIANE VEDONO CON DIFFICOLTÀ ALL'ESTERNO E I BAMBINI NON POSSONO RAGGIUNGERE L'OCCHIOLO A CAUSA DELL'ALTEZZA. IL VISORE DIGITALE SI ACCENDE SEMPLICEMENTE PREMENDO UN PULSANTE E SUBITO APPARE L'IMMAGINE SUL DISPLAY.

The new electronic system with digital viewer by Alias to replace the traditional spy-hole to get a high quality vision. Why to use the digital viewer? The digital viewer offers larger and clearer imagine. The traditional spy-hole offers a poor imagine and it doesn't let elderly people look outside easily and children can't reach the spy-hole because of the height. The digital viewer turns on pressing a button and immediately the imagines appears on the display.

Le système électronique avec viseur digital sélectionné par ALIAS pouvant remplacer l'œilleton traditionnel permettant d'obtenir une vision nette de haute qualité. Quels sont les avantages du viseur digital ? Une image fine et agrandie; tandis qu'avec l'œilleton traditionnel, l'image est réduite, les personnes âgées ont parfois des difficultés pour voir correctement et les enfants ne peuvent pas l'utiliser, du fait de la hauteur de l'œilleton. Le viseur digital s'actionne par une simple pression sur le bouton et aussitôt l'image apparaît sur l'écran.



CARATTERISTICHE TECNICHE TECHNICAL FEATURES / CARACTÉRISTIQUES TECHNIQUES

- Modello - Model - Modèle: **WISO.51.xx**
- Attacco qualsiasi porta - Attach - fixation pour toutes les portes : **55-110 mm di sp.**

- Sensore - Sensor - Senseur: **0.3 Mega Pixel CMOS**
- Schermo LCD - LCD screen - Ecran LCD
- Fonte di energia - Energy alimentation - Energie: **4 batterie stilo AA - 4 batteries 4 piles AA**
- Peso: - Weight: - Poids: **350g**

INSTALLAZIONE/installation/installation

TRAPANARE UN FORO DI 14MM NELLA PORTA A LIVELLO DELL'OCCHIO. INSERIRE LA TELECAMERA DALL'ESTERNO E ASSICURARSI CHE LA FRECCIA DAVANTI ALLA TELECAMERA PUNTI VERSO L'ALTO. MONTARE LA PIASTRA SOPRA L'ESTREMITÀ DELLE LENTI QUINDI AVVITARE IL CILINDRO DI BLOCCAGGIO ALLA PARTE FILETTATA DELLA TELECAMERA. SUCCESSIVAMENTE FISSARE LA PIASTRA CON 2 VITI (FORNITE). ASSICURARSI CHE LA FRECCIA SULLA PIASTRA PUNTI VERSO L'ALTO. IL FILO DELLA TELECAMERA DEVE ESSERE COLLEGATO ALLA PRESA DI CORRENTE NELLA PARTE POSTERIORE DEL VISORE. AGGANCIARE IL VISORE DELLA PORTA DIGITALE ATTRAVERSO LA STAFFA NELLA PARTE SUPERIORE DELLA PIASTRA DI CHIUSURA E FISSARE INSERENDO DUE VITI NEI FORI DEI BOTTONI DELLA CASSA DEL VISORE.

Make a hole of 14mm in the door at the eye-level. Insert the camera from the external side and make sure that the arrow in front of it is pointing up. Install the plate on the ends of the lens and screw the cylinder of the lock to the threaded side of the camera. After that x the plate with two screws (provided). Make sure that the arrow on the plate is pointing up. The cable of the camera should be connected to the socket with the back side of the viewer. Hook the digital viewer of the door through the bracket in the up side of the plate of the lock and x it using two screws.

Perçer un trou de 14mm dans la porte à la hauteur de l'œilleton. Insérer la caméra de l'extérieur et s'assurer que la flèche devant la caméra pointe vers le haut. Monter la plaque à l'extrémité des lentilles puis visser le cylindre de blocage à la partie filetée de la caméra. Fixer ensuite la plaque avec les 2 vis (fournies). S'assurer que la flèche sur la plaque pointe vers le haut. Le fil de la caméra doit être branché à la prise de courant dans la partie postérieure du viseur. Accrocher le viseur digital de la porte dans la partie supérieure de la plaque du verrou à l'aide d'une bride, le fixer en insérant les deux vis dans les trous réservés aux boutons du boîtier viseur.

INGOMBRI TECNICI

Technical sizes

Encombremets techniques

STEEL - VEGA PLUS - STEEL C FB6

SILVER - GOLD - PLATINUM

TITANIUM - MAGMA 39/60/90

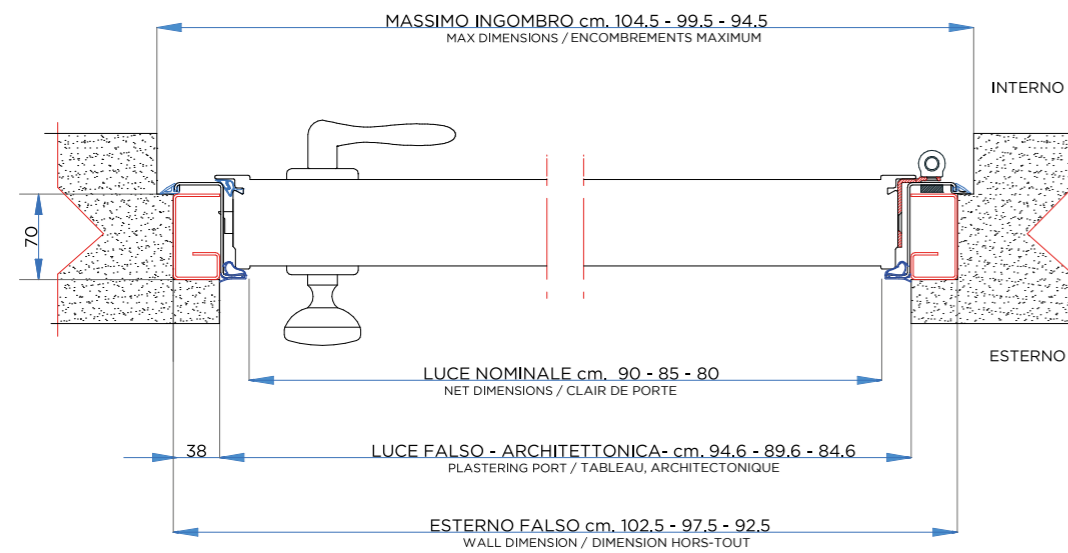
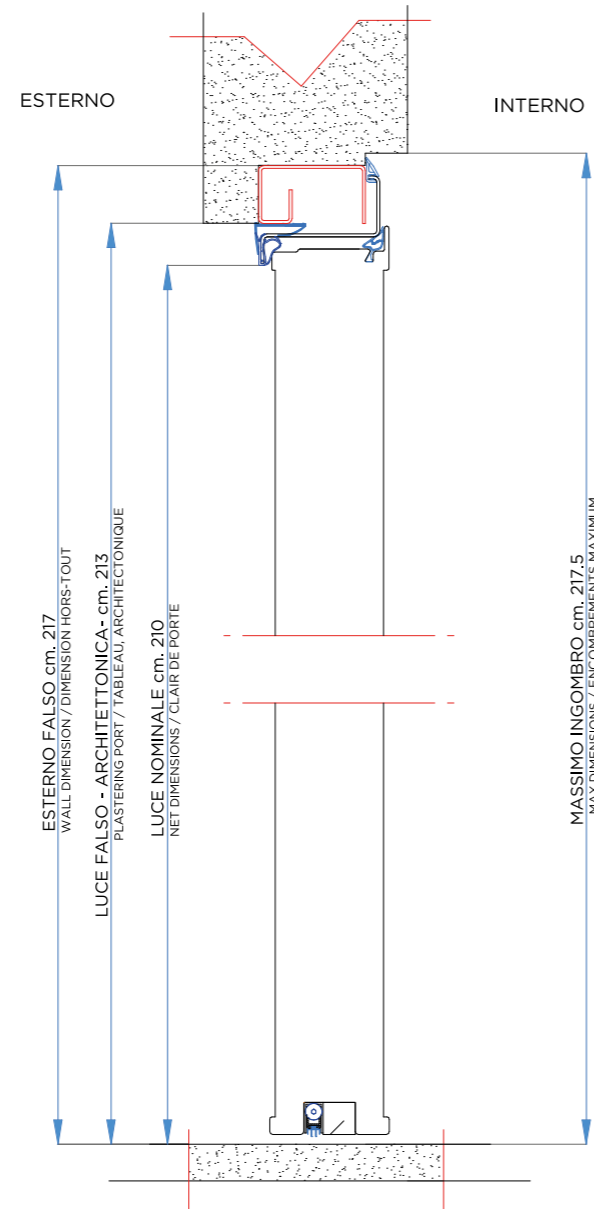
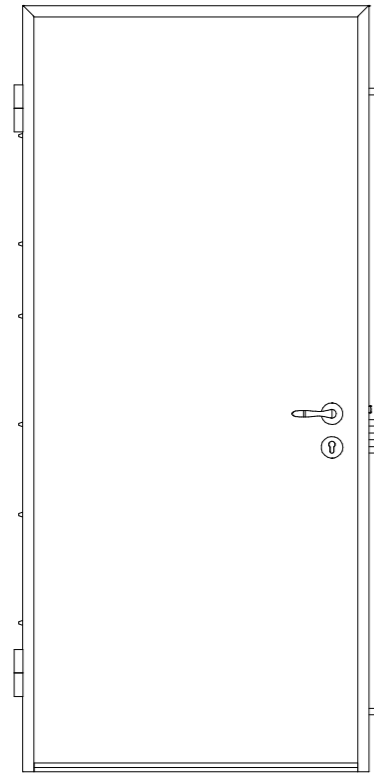

INGOMBRI TECNICI ZTL

Technical sizes ZTL

Encombremets ZTL

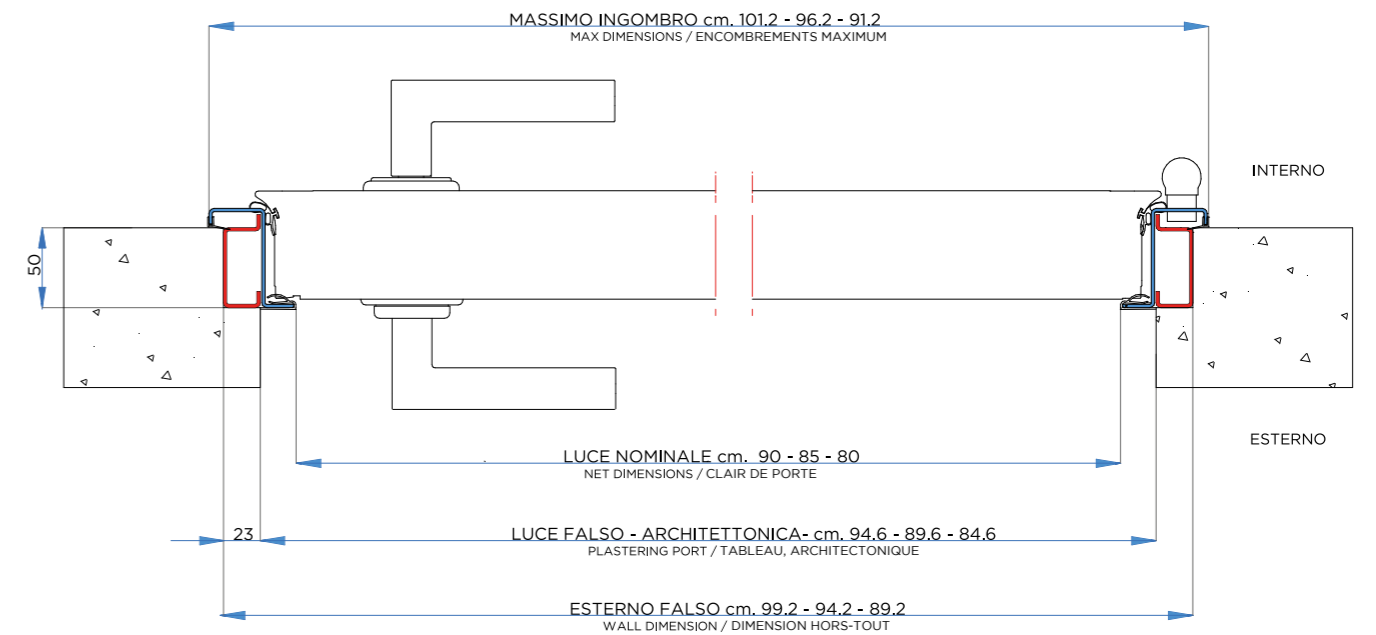
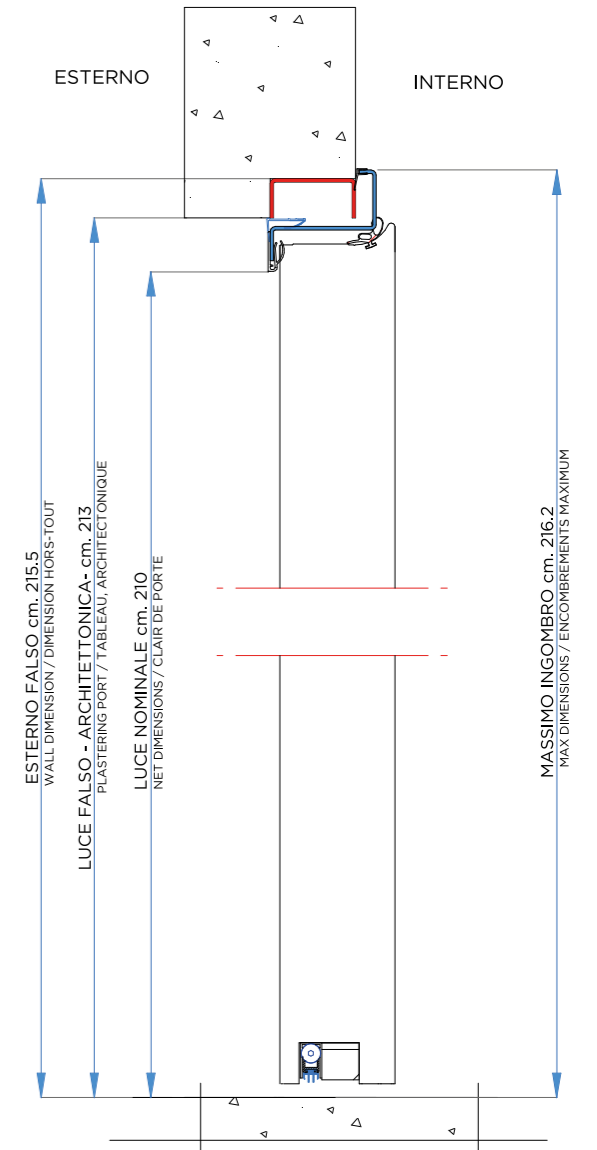
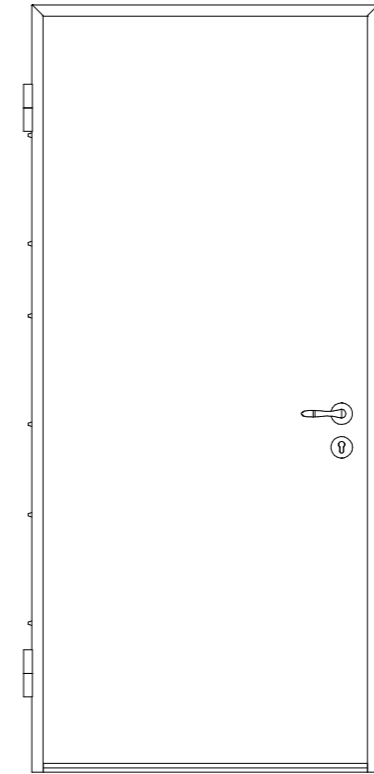

INGOMBRI TECNICI ZTL IN LUCE
Outside wall ZTL technical dimensions
Encombrements ZTL passage

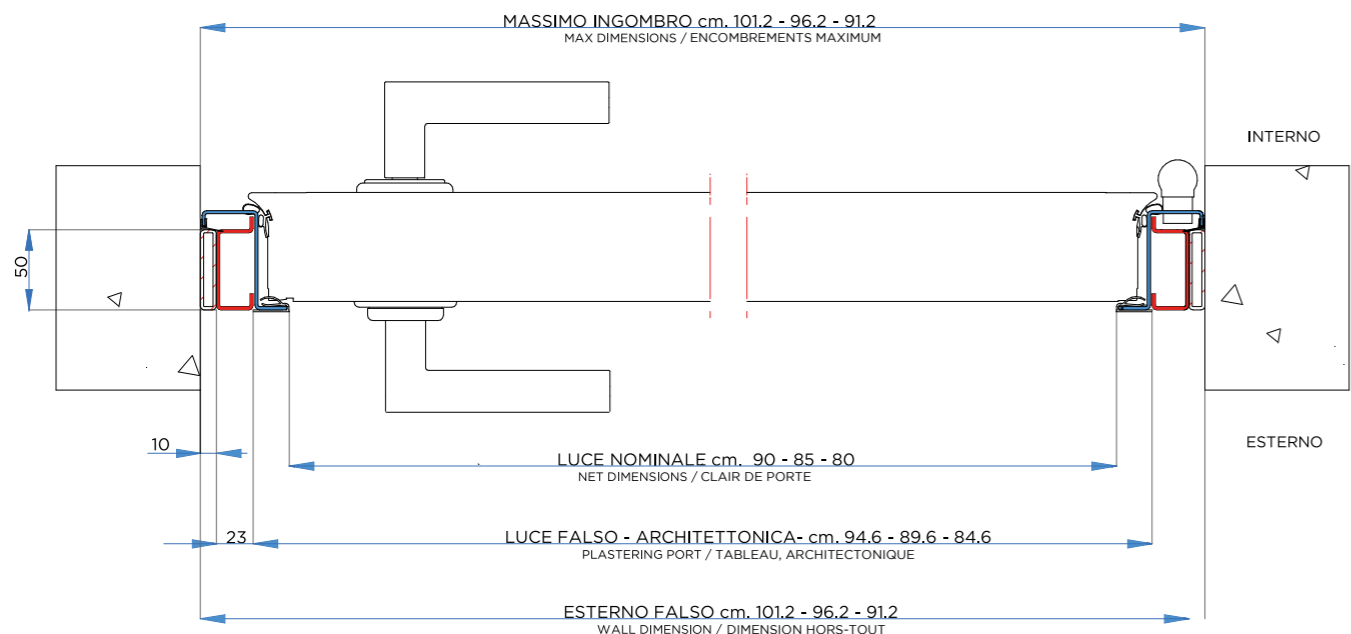
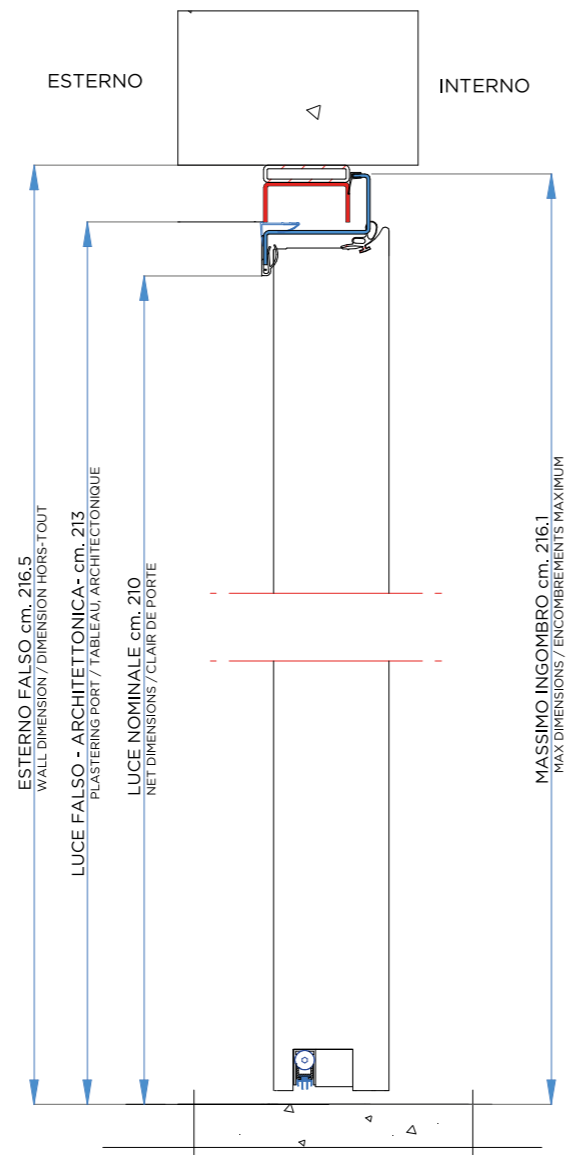
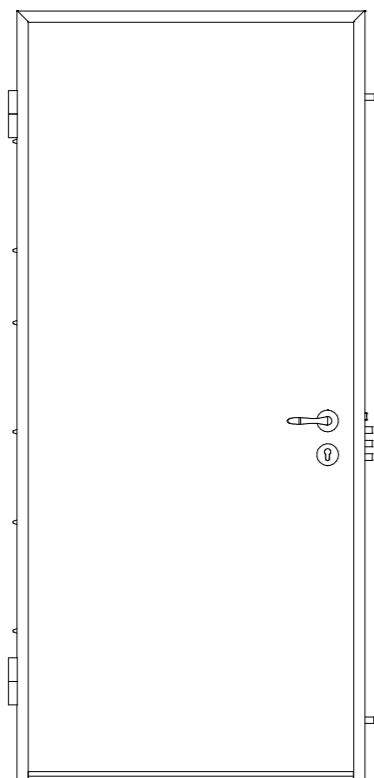

BATTUTA A PAVIMENTO A SCELTA
Bar floor
Barre de seuil au choix

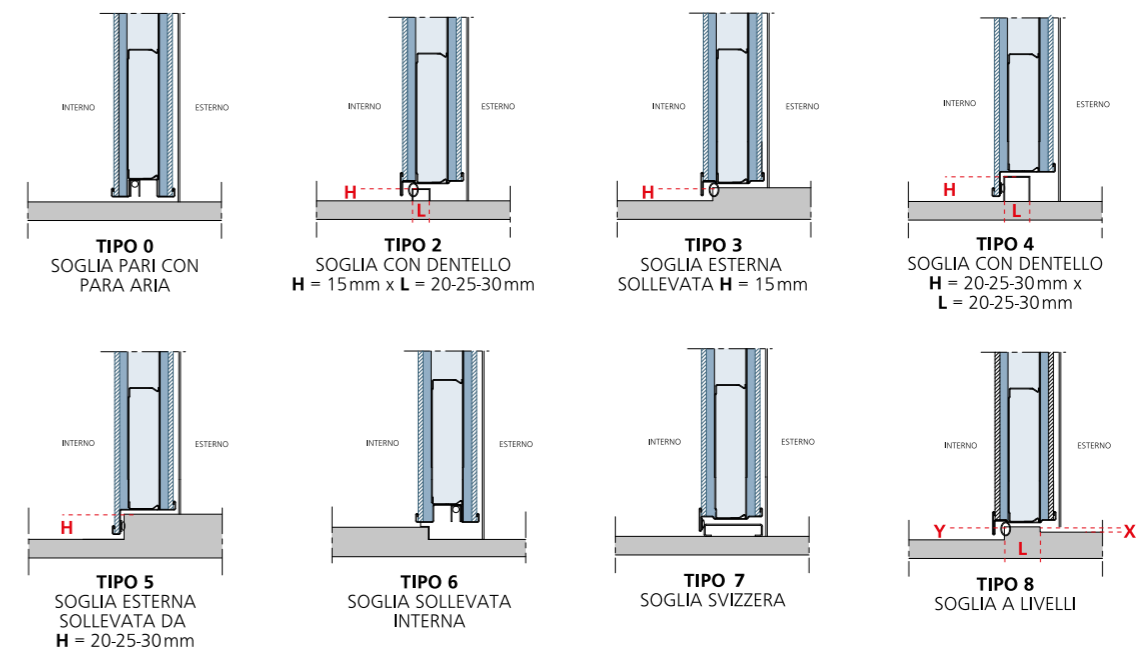

PRESTAZIONI AGGIUNTIVE AAV/dB
Additional features AAV/dB
Prestations supplémentaires AEV/dB

ALIAS PROPONE DUE NUOVE SOLUZIONI TECNICHE DALLE ALTE PRESTAZIONI, SIA PER LA PORTA BLINDATA DA ESTERNO CHE PER QUELLA DA CONDOMINIO; SONO APPLICABILI A TUTTI I MODELLI DELLA GAMMA AD ANTA SINGOLA.

ALIAS offers two new high technical performance solutions for both exterior and interior entry doors. These solutions can be fitted to all single-leaf door models.

ALIAS propose deux nouvelles solutions techniques de hautes performances, pour portes blindées extérieures comme portes d'immeubles; elles sont applicables à tous les modèles de la gamme à un seul vantail.

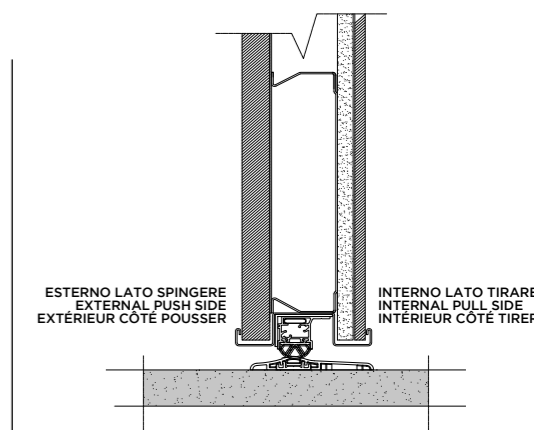

SOGLIA PER KIT ARIA - ACQUA - VENTO
Aev Kit
Seuil pour kit AEV

Set di resistenza e tenuta ad ARIA - ACQUA - VENTO AEV Kit - Kit AEV

CARATTERISTICHE CERTIFICATE DEL SET:
Certified features:
Caractéristiques certifiées:

| | Metodo di prova Test method Méthode d'essais | Classificazione Norma Rule classification Classification | Classe Class Classe |
|---|--|--|---------------------------|
| Permeabilità all'aria - Air resistance - Perméabilité à l'air | EN 1026 | EN 12207 | 4 |
| Tenuta all'acqua - Water resistance - Étanchéité | EN 1027 | EN 12208 | 5A |
| Resistenza al carico del vento Wind resistance - Résistance aux poussées du vent | EN 12211 | EN 12210 | C5 |

PER PORTE BLINDATE DA ESTERNO SOLO PER MODELLO STEEL 1 ANTA.
For security door for outside only for Steel model, one leaf.
Exclusivement pour les portes blindées extérieures modèle Steel à 1 vantail



CERTIFICATI PRESTAZIONI LEGENDA

CERTIFICATES - FEATURES - LEGEND
CERTIFICATIONS - PERFORMANCES - LÉGENDE

CERTIFICATI

Certificates / Certifications

ALIAS COLLABORA CON I PIÙ IMPORTANTI ISTITUTI DI CONTROLLO E CERTIFICAZIONE RICONOSCIUTI A LIVELLO EUROPEO PER GARANTIRE AL MEGLIO LE PRESTAZIONI E LA QUALITÀ DEI PROPRI PRODOTTI. DI SEGUITO L'ELENCO DEI PRINCIPALI CERTIFICATI E RAPPORTI DI PROVA ATTUALMENTE OTTENUTI.

ALIAS cooperates with all the major European organizations for testing and certification in order to guarantee the best performance and quality of its products. The following list includes the most important certificates and test reports obtained by ALIAS to date.

ALIAS collabore avec les Organismes de contrôle et de certification les plus importants reconnus à hauteur européenne pour garantir au mieux les performances et la qualité de ses produits. Ci-après la liste des principaux certificats et rapports d'essai actuellement obtenus.

ISO 9001:2015

| ISTITUTO INSTITUTION ORGANISMES | N. | TITOLO TITLE TITRE | PRESTAZIONE PERFORMANCE PERFORMANCES | MODELLO MODEL MODÈLE | NORME STANDARD NORMES |
|---------------------------------|----------------|----------------------|--------------------------------------|----------------------|-----------------------|
| TUV | N. 50 100 8737 | UNI EN ISO 9001:2015 | Certificazione di sistema | - | ISO 9001:2015 |

RESISTENZA ALL'EFFRAZIONE - Burglar resistance - Résistance à l'effraction

| ISTITUTO INSTITUTION ORGANISMES | N. | TITOLO TITLE TITRE | PRESTAZIONE PERFORMANCE PERFORMANCES | MODELLO MODEL MODÈLE | NORME STANDARD NORMES |
|---------------------------------|-------------------------------------|----------------------|--------------------------------------|--|------------------------|
| CSI | Rapporto di prova 0016-DC-AEF-10-01 | Effrazione | Classe 2 | DUO DOUBLE | EN 1627-1628-1629-1630 |
| CSI | Rapporto di prova 0027-DC-AEF-16 | Effrazione | Classe 3 | DUO DOUBLE | EN 1627-1628-1629-1630 |
| Istituto Giordano | Rapporto di prova 221408 | Effrazione | Classe 3 | STEEL | EN 1627-1628-1629-1630 |
| Istituto Giordano | Rapporto di prova 221407 | Effrazione | Classe 3 | SILVER | EN 1627-1628-1629-1630 |
| CNPP | Rapp. D'essai n. MD 030073 | Effrazione | Classe 3 | FORTEX | EN 1627-1628-1629-1630 |
| CNPP | Rapp. D'essai n. MD 030073 | Effrazione | Classe 3 | SECUREX | EN 1627-1628-1629-1630 |
| CSI | Rapporto di prova 0004-DC-AEF-15 | Effrazione | Classe 3 | ZTL | EN 1627-1628-1629-1630 |
| Istituto Giordano | Rapporto di prova 222871 | Effrazione | Classe 4 | PLATINUM TITANIUM | EN 1627-1628-1629-1630 |
| CSI | Rapporto di prova 0028-DC-AEF-14 | Effrazione | Classe 4 | VEGAPLUS | EN 1627-1628-1629-1630 |
| CNPP | Rapp. D'essai n. MD 040123A | Effrazione | Classe 4 | FORTEX SECUREXPLUS | EN 1627-1628-1629-1630 |
| CNPP | Certificato 39.184-01 | Effrazione | A2P* | Serratura CISA New cambio facile Doppia mappa | REGOLAMENTO CNPP |
| CNPP | Certificato 39.238-01 | Effrazione | A2P* | Serratura CISA Revolution HF e Cilindro | REGOLAMENTO CNPP |
| CNPP | Certificato 39.305-61 | Effrazione | A2P** | Serratura CISA New cambio facile HG Doppia mappa | REGOLAMENTO CNPP |
| CNPP | Certificato 39.314-61 | Effrazione | A2P** | Serratura CISA Revolution HG e Cilindro | REGOLAMENTO CNPP |
| CNPP | Certificato 19.65 | Serrures de batiment | BP1 | Securex | REGOLAMENTO CNPP |
| CSI | Rapporto di prova 0025-DC-AEF-16-1 | Effrazione | Classe 3 | GRATE DEFENDER | EN 1627-1628-1629-1630 |
| CSI | Rapporto di prova 0033/DC/AEF/17 | Effrazione | Classe 2 | GRATE FIGHTER | EN 1627-1628-1629-1630 |
| CSI | Rapporto di prova 0026-DC-AEF-18 | Effrazione | Classe 2 | DREAM | EN 1627-1628-1629-1630 |
| CSI | Rapporto di prova 0040-DC-AEF-17 | Effrazione | Classe 3 | SOPRALUCE VETRATO (VETRO P6B) | EN 1627-1628-1629-1630 |

RESISTENZA AL PROIETTILE - Bullet resistance - Résistance balistique

| ISTITUTO INSTITUTION ORGANISMES | N. | TITOLO TITLE TITRE | PRESTAZIONE PERFORMANCE PERFORMANCES | MODELLO MODEL MODÈLE | NORME STANDARD NORMES |
|---|-----------------------------------|--------------------|--------------------------------------|----------------------|-----------------------|
| Banco nazionale di prova per le armi da fuoco | Rapporto di prova N. 30/BAL-AG/VP | Balistica | FB6 | STEEL | 1522:2000 |

TENUTA ARIA ACQUA VENTO - Air Water Wind permeability - Étanchéité air-eau-vent

| ISTITUTO INSTITUTION ORGANISMES | N. | TITOLO TITLE TITRE | PRESTAZIONE PERFORMANCE PERFORMANCES | MODELLO MODEL MODÈLE | NORME STANDARD NORMES |
|---------------------------------|---------------------------------------|--------------------|---|---------------------------------------|-----------------------|
| CSI | Rapporto di prova N. 0161-DC-AAV-09-1 | Tenuta AAV | Aria: Classe 2 Acqua: NPD Vento: C2 | STEEL SILVER | EN 1026-1027-12211 |
| CSI | Rapporto di prova N. 0161-DC-AAV-09-2 | Tenuta AAV | Aria: Classe 4 Acqua: 5A Vento: C5 | STEEL SILVER | EN 1026-1027-12211 |
| Istituto Giordano | Rapporto di prova N. 267193-5060 CPD | Tenuta AAV | Aria: Classe 4 Acqua: 8A Vento: C4 | STEEL SILVER SOPRALUCE MAX FINESTRATA | EN 1026-1027-12211 |
| CEBTP | Dossier N. BP13-6-4119-1 | Tenuta AAV | Aria: Classe 2 Acqua: 4B Vento: A5 | STEEL SILVER | EN 1026-1027-12211 |

TRASMITTANZA TERMICA - Thermal transmittance - Transmission thermique

| ISTITUTO INSTITUTION ORGANISMES | N. | TITOLO TITLE TITRE | PRESTAZIONE PERFORMANCE PERFORMANCES | MODELLO MODEL MODÈLE | NORME STANDARD NORMES |
|---------------------------------|--------------------------------------|--------------------|--------------------------------------|----------------------|-----------------------|
| CSI | Rapporto di prova N.0049-DC-AEF-11-4 | Calcolo termico | 1,3 | STEEL - SILVER ECC. | 14351-1 |
| CSI | Rapporto di prova N.0049-DC-AEF-11-3 | Calcolo termico | 1 | FLAT | 14351-1 |
| CSI | Rapporto di prova N.0049-DC-AEF-11 | Calcolo termico | 1,01 | WALL | 14351-1 |
| CSI | Rapporto di prova N.0057-DC-AEF-14 | Calcolo termico | 1,4 | ZTL | 14351-1 |
| CSI | Rapporto di prova N.0056-DC-AEF-14 | Calcolo termico | 1,2 - 1,2 -1,1 | STEEL - SILVER | 14351-1 |
| CSI | Rapporto di prova N.0024-DC-AEF-16-2 | Calcolo termico | 1,4 | DUO - DOUBLE | 14351-1 |

PRESTAZIONE ACUSTICA - Acoustic performance - Indices d'affaiblissement acoustique

| ISTITUTO INSTITUTION ORGANISMES | N. | TITOLO TITLE TITRE | PRESTAZIONE PERFORMANCE PERFORMANCES | MODELLO MODEL MODÈLE | NORME STANDARD NORMES |
|---------------------------------|---|---------------------|--------------------------------------|--|-----------------------|
| CSI SpA | Rapporto di prova 0140-DC-ACU-10 | Isolamento acustico | 34 dB | STEEL SILVER | ISO 140/3 - 717/1 |
| CSI SpA | Rapporto di prova 0058-DC-ACU-13-2 | Isolamento acustico | 37 dB | STEEL SILVER | ISO 140/3 - 717/1 |
| CSI SpA | Rapporto di prova 0054B-DC-ACU-08 | Isolamento acustico | 40 dB | STEEL SILVER | ISO 140/3 - 717/1 |
| CSI SpA | Rapporto di prova 0044-DC-ACU-13 | Isolamento acustico | 40 dB | STEEL - SILVER CON SOPRALUCE | ISO 140/3 - 717/1 |
| CSI SpA | Rapporto di prova 0058-DC-ACU-13-1 | Isolamento acustico | 40 dB | STEEL SILVER | ISO 140/3 - 717/1 |
| Istituto Giordano | Rapporto di prova 180813 | Isolamento acustico | 42 dB | STEEL SILVER GOLD | ISO 140/3 - 717/1 |
| CSI SpA | Rapporto di prova 0030-DC-ACU-10 | Isolamento acustico | 44 dB | STEEL SILVER | ISO 140/3 - 717/1 |
| CSI SpA | Rapporto di prova 0054C-DC-ACU-08 | Isolamento acustico | 35 dB | STEEL - SILVER FINESTRATA (SPECCHIATURA) | ISO 140/3 - 717/1 |
| CSI SpA | Rapporto di prova 0050-DC-ACU-16 | Isolamento acustico | 41 dB | STEEL - SILVER FINESTRATA (SPECCHIATURA) | ISO 140/3 - 717/1 |
| CSI SpA | Rapporto di prova 0054D-DC-ACU-08 | Isolamento acustico | 31 dB | DUO - DOUBLE 2 ANTE | ISO 140/3 - 717/1 |
| CSI SpA | Rapporto di prova 0060-DC-ACU-16 | Isolamento acustico | 36 dB | DUO - DOUBLE 2 ANTE | ISO 140/3 - 717/1 |
| CSTB | Rapp. D'essai N. AC03-128/1 | Isolamento acustico | 41 dB | SECUREX | ISO 140/3 - 717/1 |
| CSTB | Rapp. D'essai N. AC03-128/2 | Isolamento acustico | 40 dB | FORTEX | ISO 140/3 - 717/1 |
| Istituto Giordano | Rapporto di prova 180812 | Isolamento acustico | 38 dB | MAGMA-C | ISO 140/3 - 717/1 |
| CSI SpA | Rapporto di prova 0021-DC-ACU-12/1 | Isolamento acustico | 42 dB | MAGMA-C | ISO 140/3 - 717/1 |
| CSI SpA | Rapporto di prova 0021-DC-ACU-12/2 | Isolamento acustico | 40 dB | MAGMA-C | ISO 140/3 - 717/1 |
| CSI SpA | Rapporto di prova 0034-DC-ACU-13 | Isolamento acustico | 35 dB - 42 dB | MAGMA-30 | ISO 140/3 - 717/1 |
| CSI SpA | Rapporto di prova 0061-DC-ACU-11/1 | Isolamento acustico | 36 dB - 38 dB | WING WALL | ISO 140/3 - 717/1 |
| CSI SpA | Rapporto di prova 0061-DC-ACU-11/2 | Isolamento acustico | 39 dB | WING WALL | ISO 140/3 - 717/1 |
| CSI SpA | Rapporto di prova 0011-DC-ACU-15/1+all1 | Isolamento acustico | 35 dB - 41 dB | ZTL | ISO 140/3 - 717/1 |
| CSI SpA | Rapporto di prova 0051-DC-ACU-16 | Isolamento acustico | 39 dB | FLAT | ISO 140/3 - 717/1 |

RESISTENZA AL FUOCO - Fire resistance - Coupe-feu

| ISTITUTO INSTITUTION ORGANISMES | N. | TITOLO TITLE TITRE | PRESTAZIONE PERFORMANCE PERFORMANCES | MODELLO MODEL MODÈLE | NORME STANDARD NORMES |
|---------------------------------|---|------------------------------|--------------------------------------|----------------------|-----------------------|
| CSI SpA | Rapp. di prova CSI1421FR | Prova di resistenza al fuoco | EI1-30 | MAGMA EI1 30 | EN 1634-1 |
| CSI SpA | Rapp. di prova CSI1401FR PC201REI030P002 | Prova di resistenza al fuoco | EI2-30 | MAGMA 30 | EN 1634-1 |
| EFFECTIS | P.V. 11-A-044 | Prova di resistenza al fuoco | EI2-30 | MAGMA 30 | EN 1634-1 |
| Istituto Giordano | Rapp. di prova 179557/2593RF omolog. C201REI060P001F1 | Prova di resistenza al fuoco | REI-60 | MAGMA-C | EN 1634-1 |
| VKF | Rapp.di class. N.20293 | Prova di resistenza al fuoco | EI2-30 | MAGMA 30 | EN 1634-1 |
| PAVUS A.S. | C216/C5A/2016/0065 | Prova di resistenza al fuoco | EI2-30 | MAGMA 30 | EN 1634-1 |
| ZAG | REG2-00004-03-ZGPro1-2734 | Prova di resistenza al fuoco | EI2-30 | MAGMA 30 | EN 1634-1 |
| EFFECTIS | PV 11-V-163 | Prova di resistenza al fuoco | EI2-30 | SECUREX | EN 1634-1 |
| CSI SpA | Rapp.di prova CSI1726FR | Prova di resistenza al fuoco | EI2-30 | FORTEX | EN 1634-1 |
| EFFECTIS | PV 12-A-399P | Prova di resistenza al fuoco | EI2-30 | FORTEX | EN 1634-1 |
| CSI SpA | Rapp.di prova CSI1694FR | Prova di resistenza al fuoco | EI2-30 | "SECUREX renovation" | EN 1634-1 |
| EFFECTIS | PV 12-A-069P | Prova di resistenza al fuoco | EI2-30 | "SECUREX renovation" | EN 1634-1 |
| CSI SpA | Rapp.di prova CSI1781FR omolog.PC201EI2060P003 | Prova di resistenza al fuoco | EI2-60 | WALL EI2-60 | EN 1634-1 |
| VKF | Rapp.di prova N. 26016 | Prova di resistenza al fuoco | EI2-60 | WALL EI2-60 | EN 1634-1 |
| CSI SpA | Rapp.di prova CSI1764FR omolog.PC201EI2045P006 | Prova di resistenza al fuoco | EI2-45 | STEEL CF 15 | EN 1634-1 |
| CSI SpA | Rapp.di prova CSI1874FR omolog.PC201EI2060P003 | Prova di resistenza al fuoco | EI2-30 | MAGMA CS30 | EN 1634-1 |
| CSI SpA | Rapp.di prova CSI1919FR omolog.PC201EI2060P004 | Prova di resistenza al fuoco | EI2-60 | MAGMA C EI2-60 | EN 1634-1 |
| CSI SpA | Rapp.di prova CSI2023FR omolog.PC201EI2090P007 | Prova di resistenza al fuoco | EI2-90 | MAGMA 90 | EN 1634-1 |
| VKF | N. 30188 | Prova di resistenza al fuoco | EI2-30 | FORTEX | EN 1634-1 |

REQUISITO DI TENUTA AI FUMI FREDDI - Smoke leakage at ambient temperature - Étanchéité aux vapeurs froides

| ISTITUTO INSTITUTION ORGANISMES | N. | TITOLO TITLE TITRE | PRESTAZIONE PERFORMANCE PERFORMANCES | MODELLO MODEL MODÈLE | NORME STANDARD NORMES |
|---------------------------------|----------------------------|------------------------------------|--------------------------------------|--|-------------------------|
| CSI SpA | Rapp.di prova DC02-001-F17 | Requisito di tenuta ai fumi freddi | Sa | STEEL MAGMA 30 MAGMA 60 MAGMA 90 SECUREX | EN 1634-3 EN 13501-2 |

CERTIFICATI DI COSTANZA PRESTAZIONI - Certificate of constancy of performance - Certificat de constance des performance

| ISTITUTO INSTITUTION ORGANISMES | N. | TITOLO TITLE TITRE | PRESTAZIONE PERFORMANCE PERFORMANCES | MODELLO MODEL MODÈLE | NORME STANDARD NORMES |
|---------------------------------|--|---|--|---|-------------------------------------|
| CSI SPA | 0497/CPR/5663 0497/CPR/5711 0497/CPR/5712 0497/CPR/5713 | Certificato di Costanza delle prestazioni | EI2-60 / Sa /C4 EI2-30 / Sa /C4 EI2-60 / Sa /C4 EI2-90 / Sa /C4 | SECUREX MAGMA EI2-30 MAGMA EI2-60 MAGMA EI2-90 | EN 16034 Regolamento 305/2011 UE |

PRESTAZIONI

Features / Performances

| MODELLO MODEL MODÈLE | ANTA FINESTRATA GLAZED DOOR PORTE VITRÉE | SOPRALUCE GLAZED TRANSOM PUIT DE LUMIÈRE SUPÉRIEUR | SET ACUSTICO ACOUSTIC INSULATION ISOLATION PHONIQUE | RIVESTIMENTI PANELS - REVÊTEMENTS | | COIBENTAZIONE * INSULATION ISOLATION | | TERMICA THERMIC-THERMIQUE W/(m²K) UNI EN 10077-1-2 | EFFRAZIONE ANTI BURGLARY EFFRACTION UNI EN 1627 1628 -1630 | ACUSTICA ACOUSTIC PHONIQUE ISO 717 ISO 140 | ARIA-ACQUA-VENTO** AIR-WATER-WIND / AIR-EAU-VENT EN 1026-1027-12211 | |
|--------------------------------------|---|---|--|---|--|---|--|--|--|--|---|--|
| | | | | INTERNO INTERNAL SIDE PANNEAUX INTÉRIEUR | ESTERNO EXTERNAL SIDE PANNEAUX EXTÉRIEUR | INTERNO INTERNAL SIDE PANNEAUX INTÉRIEUR | ESTERNO EXTERNAL SIDE PANNEAUX EXTÉRIEUR | | | | PARA ARIA BOTTOM MOVABLE SILL CORTA VIENTO INFERIOR | SOGLIA AAV AIR-WATER-WIND THRESHOLD SEUIL AEV |
| | | | | | | | | | | | | |
| STEEL SILVER STEELPLUS GOLD | NO | NO | NO | L | ABS | SI | NO | 1,1 | 3 | 34 dB | 2-NPD-C2 | 4 - 5A - C5 |
| | | | | L | L | SI | SI | 1,3 | | | | |
| | | | | L | P | SI | AEROGEL | 1,1 | | | | |
| | | | | L | P | SI | SI | 1,3 | | | | |
| | | | | L | P | SI | AEROGEL | 1 | | | | |
| | | | | L | P | SI | NO | 1,6 | | | | |
| | | | | L | ALU | SI | SI | 1,8 | | | | |
| | | | | L | ALU | SI | AEROGEL | 1,4 | | | | |
| | | | | L | ALU | SI | NO | 2,5 | | | | |
| | | | | P | P | NO | SI | 1,6 | | | | |
| | | | | P | P | NO | NO | 2,5 | | | | |
| | | | | P | P | SI | SI | 1,2 | | | | |
| | L | ABS | SI | NO | 1,1 | | | | | | | |
| | L | L | SI | SI | 1,2 | | | | | | | |
| | L | P | SI | SI | 1,2 | | | | | | | |
| | L | P | SI | NO | 1,8 | | | | | | | |
| | L | ALU | SI | SI | 1,8 | | | | | | | |
| | L | ALU | SI | NO | 2,5 | | | | | | | |
| | P | P | NO | SI | 1,6 | | | | | | | |
| | P | P | NO | NO | 2,5 | | | | | | | |
| | P | P | SI | SI | 1,2 | | | | | | | |
| | L | ABS | SI | NO | 1,1 | | | | | | | |
| | L | L | SI | SI | 1,2 | | | | | | | |
| | L | P | SI | SI | 1,2 | | | | | | | |
| L | P | SI | NO | 1,8 | | | | | | | | |
| L | ALU | SI | SI | 1,8 | | | | | | | | |
| L | ALU | SI | NO | 2,5 | | | | | | | | |
| P | P | NO | SI | 1,6 | | | | | | | | |
| P | P | NO | NO | 2,5 | | | | | | | | |
| P | P | SI | SI | 1,2 | | | | | | | | |
| L | ABS | SI | NO | 1,1 | | | | | | | | |
| L | L | SI | SI | 1,4 | | | | | | | | |
| L | P | SI | SI | 1,4 | | | | | | | | |
| L | P | SI | NO | 2 | | | | | | | | |
| L | ALU | SI | SI | 1,8 | | | | | | | | |
| L | ALU | SI | NO | 2,5 | | | | | | | | |
| P | P | NO | SI | 1,6 | | | | | | | | |
| P | P | NO | NO | 2,4 | | | | | | | | |
| P | P | SI | SI | 1,4 | | | | | | | | |
| L | ABS | SI | NO | 1,2 | | | | | | | | |
| L | L | SI | SI | 1,5 | | | | | | | | |
| L | L | SI | AEROGEL | 1,4 | | | | | | | | |
| L | P | SI | SI | 1,4 | | | | | | | | |
| L | P | SI | AEROGEL | 1,3 | | | | | | | | |
| L | P | SI | NO | 1,7 | | | | | | | | |
| L | ALU | SI | SI | 2 | | | | | | | | |
| L | ALU | SI | NO | 2,5 | | | | | | | | |
| P | P | NO | SI | 1,8 | | | | | | | | |
| P | P | NO | NO | 2,2 | | | | | | | | |
| P | P | SI | SI | 1,4 | | | | | | | | |
| L | ABS | SI | NO | 1,3 | | | | | | | | |
| L | L | SI | SI | 1,4 | | | | | | | | |
| L | P | SI | SI | 1,4 | | | | | | | | |
| L | P | SI | NO | 1,7 | | | | | | | | |
| L | ALU | SI | SI | 2 | | | | | | | | |
| L | ALU | SI | NO | 2,5 | | | | | | | | |
| P | P | NO | SI | 1,8 | | | | | | | | |
| P | P | NO | NO | 2,2 | | | | | | | | |
| P | P | SI | SI | 1,4 | | | | | | | | |
| L | ABS | SI | NO | 1,3 | | | | | | | | |
| L | L | SI | SI | 1,4 | | | | | | | | |
| L | P | SI | SI | 1,4 | | | | | | | | |
| L | P | SI | NO | 2 | | | | | | | | |
| L | ALU | SI | SI | 2 | | | | | | | | |
| L | ALU | SI | NO | 2,5 | | | | | | | | |
| P | P | NO | SI | 1,8 | | | | | | | | |
| P | P | NO | NO | 2,5 | | | | | | | | |
| P | P | SI | SI | 1,4 | | | | | | | | |

| MODELLO MODEL MODÈLE | ANTA FINESTRATA GLAZED DOOR PORTE VITRÉE | SOPRALUCE GLAZED TRANSOM PUIT DE LUMIÈRE SUPÉRIEUR | SET ACUSTICO ACOUSTIC INSULATION ISOLATION PHONIQUE | RIVESTIMENTI PANELS - REVÊTEMENTS | | COIBENTAZIONE * INSULATION ISOLATION | | TERMICA THERMIC-THERMIQUE W/(m²K) UNI EN 10077-1-2 | EFFRAZIONE ANTI BURGLARY EFFRACTION UNI EN 1627 1628 -1630 | ACUSTICA ACOUSTIC PHONIQUE ISO 717 ISO 140 | ARIA-ACQUA-VENTO** AIR-WATER-WIND / AIR-EAU-VENT EN 1026-1027-12211 | | |
|---|---|---|--|---|--|---|--|--|--|--|---|--|-------------|
| | | | | INTERNO INTERNAL SIDE PANNEAUX INTÉRIEUR | ESTERNO EXTERNAL SIDE PANNEAUX EXTÉRIEUR | INTERNO INTERNAL SIDE PANNEAUX INTÉRIEUR | ESTERNO EXTERNAL SIDE PANNEAUX EXTÉRIEUR | | | | PARA ARIA BOTTOM MOVABLE SILL CORTA VIENTO INFERIOR | SOGLIA AAV AIR-WATER-WIND THRESHOLD SEUIL AEV | |
| | | | | | | | | | | | | | L |
| STEEL SILVER STEELPLUS GOLD | VETROCAMERA DOPPIA (sp.50mm) | NO | Con para aria acustico | P | P | SI | SI | 1,3 | NPD | 41 dB | 2-NPD-C2 | 4 - 8A - C4 | |
| | | | | P | ALU | SI | SI | 1,4 | | | | | |
| | | P | P | SI | SI | 1,6 | | | | | | | |
| | | P | ALU | SI | SI | 1,7 | | | | | | | |
| | VETROCAMERA (Sp.36mm) | NO | NO | | P | P | NO | NO | 2,2 | NPD | 35 dB | 2-NPD-C2 | 4 - 8A - C4 |
| | | | | | P | ALU | NO | NO | 2,5 | | | | |
| | | P | P | NO | NO | 2,3 | | | | | | | |
| | | P | ALU | NO | NO | 2,5 | | | | | | | |
| VETROCAMERA (Sp.36mm) | SI | NO | | P | P | NO | NO | 2,3 | NPD | NPD | 2-NPD-C2 | 4 - 8A - C4 | |
| | | | | P | ALU | NO | NO | 2,5 | | | | | |
| THERMAL STEEL/SILVER (2) | NO | NO | "PARA ARIA ACUSTICO" | L | L | SI | AEROGEL | 0,8 | 3 | 40 dB | NPD | NPD | |
| | | | | L | P | SI | AEROGEL | 0,8 | | | | | |
| ISOLA STEEL/SILVER (2) | NO | NO | "PARA ARIA ACUSTICO" | L | L | SI | SI | 1 | 3 | 40 dB | NPD | NPD | |
| | | | | L | P | SI | SI | 1 | | | | | |
| STEEL FB6 ANTIPROIETTILE | | | | | | | | 1,8 | 3 | 34 dB | 2-NPD-C2 | NPD | |
| | | | | | | | | | | | | | |
| DUO DOUBLE | NO | NO | NO | L | ABS | SI | NO | 1,4 | 3 | 36 dB | NPD | NPD | |
| | | | | L | L | SI | SI | 1,4 | | | | | |
| | | | | L | P | SI | SI | 1,4 | | | | | |
| | | | | L | P | SI | NO | 1,6 | | | | | |
| | | | | L | ALU | SI | SI | 2 | | | | | |
| | | | | L | ALU | SI | NO | 2,5 | | | | | |
| | | | | P | P | NO | SI | 1,5 | | | | | |
| | | | | P | P | NO | NO | 2 | | | | | |
| | L | ABS | SI | NO | 1,5 | | | | | | | | |
| | L | L | SI | SI | 1,6 | | | | | | | | |
| | L | P | SI | SI | 1,6 | | | | | | | | |
| | L | P | SI | NO | 1,7 | | | | | | | | |
| | L | ALU | SI | SI | 2,2 | | | | | | | | |
| | L | ALU | SI | NO | 2,5 | | | | | | | | |
| | P | P | NO | SI | 1,7 | | | | | | | | |
| | P | P | NO | NO | 2 | | | | | | | | |
| P | P | SI | SI | 1,6 | | | | | | | | | |
| VETROCAMERA DOPPIA (sp.50mm) ¹ | NO | NO | | P | P | SI | SI | 1,4 | NPD | NPD | NPD | NPD | |
| VETROCAMERA DOPPIA (sp.50mm) ¹ | SI | NO | | P | ALU | SI | SI | 1,6 | NPD | NPD | NPD | NPD | |
| VETROCAMERA (Sp.36mm) ¹ | NO | NO | | P | P | NO | NO | 2,2 | NPD | 31 dB | NPD | NPD | |
| | | | | P | ALU | NO | NO | 2,5 | | | | | |
| VETROCAMERA (Sp.36mm) ¹ | SI | NO | | P | P | NO | NO | 2,5 | NPD | NPD | NPD | NPD | |
| VETROCAMERA (Sp.36mm) ¹ | SI | NO | | P | ALU | NO | NO | 2,5 | NPD | NPD | NPD | NPD | |

¹ PRESTAZIONI VALIDE PER PORTE DUO/DOUBLE IN CUI SOLO UNA DELLE DUE ANTE E' FINESTRATA
¹ THESE PERFORMANCES ARE VALID FOR DUO/DOUBLE MODELS IN WHICH ONLY ONE OF THE TWO LEAVES IS GLAZED
¹ PRESTACIONES VÁLIDAS PARA LOS MODELOS DUO/DOUBLE CON VENTANA EN UNA SÓLA HOJA

| MODELLO MODEL MODÈLE | ANTA FINESTRATA GLAZED DOOR PORTE VITRÉE | SOPRALUCE GLAZED TRANSOM PUIT DE LUMIÈRE SUPÉRIEUR | SET ACOUSTIC INSULATION ISOLATION PHONIQUE | RIVESTIMENTI PANELS - REVÊTEMENTS | | COIBENTAZIONE * INSULATION ISOLATION | | TERMICA THERMIC-THERMIQUE W/(m²K) UNI EN 10077-1-2 | EFFRAZIONE ANTI BURGLARY EFFRACTION UNI EN 1627 1628 -1630 | ACUSTICA ACOUSTIC PHONIQUE ISO 717 ISO 140 | ARIA-ACQUA-VENTO** AIR-WATER-WIND / AIR-EAU-VENT EN 1026-1027-12211 | |
|------------------------------------|---|---|--|---|--|---|--|--|--|--|---|--|
| | | | | INTERNO INTERNAL SIDE Panneaux Intérieur | ESTERNO EXTERNAL SIDE Panneaux Extérieur | INTERNO INTERNAL SIDE Panneaux Intérieur | ESTERNO EXTERNAL SIDE Panneaux Extérieur | | | | PARA ARIA BOTTOM MOVABLE SILL CORTA VIENTO INFERIOR | SOGLIA AAV AIR-WATER-WIND THRESHOLD SEUIL AEV |
| | | | | | | | | | | | | |
| PLATINUM TITANIUM VEGAPLUS | NO | NO | NO | L | ABS | SI | NO | 1,4 | 4 | 35 dB | NPD | NPD |
| | | | | L | L | SI | SI | 1,8 | | | | |
| | | | | L | L | SI | AEROGEL | 1,3 | | | | |
| | | | | L | P | SI | SI | 1,4 | | | | |
| | | | | L | P | SI | AEROGEL | 1,2 | | | | |
| | | | | L | P | SI | NO | 2,2 | | | | |
| | | | | L | ALU | SI | SI | 2 | | | | |
| | | | | L | ALU | SI | NO | 2,5 | | | | |
| | | | | P | P | NO | SI | 1,8 | | | | |
| | | | | P | P | NO | NO | 2,5 | | | | |
| | P | P | SI | SI | 1,8 | | | | | | | |
| | NO | NO | 40 dB | L | ABS | SI | NO | 1,9 | 4 | 40 dB | NPD | NPD |
| | | | | L | L | SI | SI | 1,9 | | | | |
| | | | | L | P | SI | SI | 1,9 | | | | |
| | | | | L | P | SI | NO | 2,3 | | | | |
| | | | | L | ALU | SI | SI | 2,1 | | | | |
| | | | | L | ALU | SI | NO | 2,5 | | | | |
| | | | | P | P | NO | SI | 1,9 | | | | |
| | | | | P | P | NO | NO | 2,5 | | | | |
| | P | P | SI | SI | 1,9 | | | | | | | |
| | NO | NO | 44 dB | L | ABS | SI | NO | 1,9 | NPD | 44 dB | NPD | NPD |
| | | | | L | L | SI | SI | 1,9 | | | | |
| | | | | L | P | SI | SI | 1,9 | | | | |
| | | | | L | P | SI | NO | 2,3 | | | | |
| | | | | L | ALU | SI | SI | 2,1 | | | | |
| | | | | L | ALU | SI | NO | 2,5 | | | | |
| | | | | P | P | NO | SI | 1,9 | | | | |
| | | | | P | P | NO | NO | 2,5 | | | | |
| P | P | SI | SI | 1,9 | | | | | | | | |
| NO | SI | NO | L | ABS | SI | NO | 2 | NPD | NPD | NPD | NPD | |
| | | | L | L | SI | SI | 2 | | | | | |
| | | | L | P | SI | SI | 2 | | | | | |
| | | | L | P | SI | NO | 2,4 | | | | | |
| | | | L | ALU | SI | SI | 2,2 | | | | | |
| | | | L | ALU | SI | NO | 2,5 | | | | | |
| | | | P | P | NO | SI | 2 | | | | | |
| | | | P | P | NO | NO | 2,5 | | | | | |
| P | P | SI | SI | 2 | | | | | | | | |
| NO | SI | 40 dB | L | ABS | SI | NO | 2,1 | NPD | 40 dB | NPD | NPD | |
| | | | L | L | SI | SI | 2,1 | | | | | |
| | | | L | P | SI | SI | 2,1 | | | | | |
| | | | L | P | SI | NO | 2,5 | | | | | |
| | | | L | ALU | SI | SI | 2,5 | | | | | |
| | | | L | ALU | SI | NO | 2,5 | | | | | |
| | | | P | P | NO | SI | 2,1 | | | | | |
| | | | P | P | NO | NO | 2,5 | | | | | |
| P | P | SI | SI | 2,1 | | | | | | | | |
| VETROCAMERA DOPPIA (sp.50mm) | NO | Con para aria acustico | P | P | SI | SI | 1,3 | NPD | 41 dB | NPD | NPD | |
| VETROCAMERA DOPPIA (sp.50mm) | SI | NO | P | P | SI | SI | 1,6 | NPD | NPD | NPD | NPD | |
| | | | P | ALU | SI | SI | 1,7 | | | | | |
| VETROCAMERA (Sp.36mm) | NO | NO | P | P | NO | NO | 2,2 | NPD | 35 dB | NPD | NPD | |
| | | | P | ALU | NO | NO | 2,5 | | | | | |
| VETROCAMERA (Sp.36mm) | SI | NO | P | P | NO | NO | 2,3 | NPD | NPD | NPD | NPD | |
| | | | P | ALU | NO | NO | 2,5 | | | | | |

| MODELLO MODEL MODÈLE | ANTA FINESTRATA GLAZED DOOR PORTE VITRÉE | SOPRALUCE GLAZED TRANSOM PUIT DE LUMIÈRE SUPÉRIEUR | SET ACOUSTIC INSULATION ISOLATION PHONIQUE | RIVESTIMENTI PANELS - REVÊTEMENTS | | COIBENTAZIONE * INSULATION ISOLATION | | TERMICA THERMIC-THERMIQUE W/(m²K) UNI EN 10077-1-2 | EFFRAZIONE ANTI BURGLARY EFFRACTION UNI EN 1627 1628 -1630 | ACUSTICA ACOUSTIC PHONIQUE ISO 717 ISO 140 | ARIA-ACQUA-VENTO** AIR-WATER-WIND / AIR-EAU-VENT EN 1026-1027-12211 | | | | | |
|-------------------------------------|---|---|--|---|--|---|--|--|--|--|---|--|----|-------|-----|-----|
| | | | | INTERNO INTERNAL SIDE Panneaux Intérieur | ESTERNO EXTERNAL SIDE Panneaux Extérieur | INTERNO INTERNAL SIDE Panneaux Intérieur | ESTERNO EXTERNAL SIDE Panneaux Extérieur | | | | PARA ARIA BOTTOM MOVABLE SILL CORTA VIENTO INFERIOR | SOGLIA AAV AIR-WATER-WIND THRESHOLD SEUIL AEV | | | | |
| | | | | | | | | | | | | | SI | NO | SI | NO |
| ZTL | NO | NO | NO | L | L | SI | NO | 1,4 | 3 | 35 dB | NPD | NO | | | | |
| | | | | L | P | SI | NO | 1,4 | | | | | | | | |
| | | | | L | ALU | SI | NO | 1,8 | | | | | | | | |
| | | | | P | L | NO | NO | 1,6 | | | | | | | | |
| | | | | P | P | NO | NO | 1,6 | | | | | | | | |
| | | | | P | P | SI | NO | 1,4 | | | | | | | | |
| | | | | L | L | SI | NO | 1,4 | | | | | | | | |
| | | | | L | P | SI | NO | 1,4 | | | | | | | | |
| | | | | L | ALU | SI | NO | 1,8 | | | | | | | | |
| | | | | P | L | NO | NO | 1,6 | | | | | | | | |
| FLAT Silver Gold | NO | NO | Con para aria acustico | L | L | SI | NO | 1,6 | NPD | NPD | NPD | NO | | | | |
| | | | | L | P | SI | NO | 1,6 | | | | | | | | |
| | | | | L | ALU | SI | NO | 2 | | | | | | | | |
| | | | | P | L | NO | NO | 1,8 | | | | | | | | |
| | | | | P | P | NO | NO | 1,8 | | | | | | | | |
| | | | | P | P | SI | NO | 1,6 | | | | | | | | |
| | | | | FLAT | ABS | SI | SI | 1 | | | | | | | | |
| | | | | FLAT | L | SI | SI | 1 | | | | | | | | |
| FLAT Platinum Titanium | NO | NO | Con para aria acustico | FLAT | P | SI | SI | 1 | 4 | 39 dB | NPD | NPD | | | | |
| | | | | FLAT | P | SI | NO | 1,2 | | | | | | | | |
| | | | | FLAT | ALU | SI | SI | 1,4 | | | | | | | | |
| | | | | FLAT | ALU | SI | NO | 1,8 | | | | | | | | |
| | | | | FLAT | L | SI | SI | 1,4 | | | | | | | | |
| | | | | FLAT | P | SI | SI | 1,4 | | | | | | | | |
| | | | | FLAT | P | SI | NO | 1,6 | | | | | | | | |
| | | | | FLAT | ALU | SI | SI | 2 | | | | | | | | |
| FLAT | ALU | SI | NO | 2,5 | | | | | | | | | | | | |
| WING Silver WALL Silver | NO | NO | NO | WALL | ABS | SI | SI | 1 | 3 | 36 dB | NPD | NPD | | | | |
| | | | | WALL | L | SI | SI | 1 | | | | | | | | |
| | | | | WALL | P | SI | SI | 1 | | | | | | | | |
| | | | | WALL | P | SI | NO | 1,2 | | | | | | | | |
| | | | | WALL | ALU | SI | SI | 1,4 | | | | | | | | |
| | | WALL | ALU | SI | NO | 1,8 | | | | | | | | | | |
| | | NO | 40 dB | WALL | ABS | SI | SI | 1 | | | | | 3 | 39 dB | NPD | NPD |
| | | | | WALL | L | SI | SI | 1 | | | | | | | | |
| | | | | WALL | P | SI | SI | 1 | | | | | | | | |
| | | | | WALL | P | SI | NO | 1,2 | | | | | | | | |
| WALL | ALU | | | SI | SI | 1,4 | | | | | | | | | | |
| WALL | ALU | SI | NO | 1,8 | | | | | | | | | | | | |
| WING / WALL Platinum Titanium | NO | NO | NO | | | | | NPD | 4 | 36 dB | NPD | NPD | | | | |
| VOLTA Steel | NO | NO | NO | | | | | 1,3 | NPD | 34 dB | NPD | NPD | | | | |
| VOLTA Duo | NO | NO | NO | | | | | 1,5 | NPD | 36 dB | NPD | NPD | | | | |

| MODELLO MODEL MODELO | ANTA FINISTRATA GLAZED DOOR PUERTA CON VIDRIO | SOPRALUCE GLAZED TRANSOM HAY UNA LUMBRERA | SET ACUSTICO ACOUSTIC INSULATION AISLAMIENTO ACUSTICO* | RIVESTIMENTI PANELS - TABLEROS | | COIBENTAZIONE * INSULATION AISLAMIENTO TERMICO | | TERMICA THERMIC-THERMIQUE W/(m²K) UNI EN 10077-1-2 | EFFRAZIONE ANTI BURGLARY EFFRACTION UNI EN 1627 1628 -1630 | ACUSTICA ACOUSTIC PHONIQUE ISO 717 ISO 140 | RESISTENZA AL FUOCO FIRE RESISTANCE COUPE-FEU | | LIMITI DIMENSIONALI DIMENSIONAL LIMITATIONS LIMITES DIMENSIONNELLES | | | | |
|----------------------------|---|---|---|---|--|--|--|--|--|--|---|-----------|---|-----------------|------|------|----------|
| | | | | INTERNO INTERNAL SIDE PARTE INTERIOR | ESTERNO EXTERNAL SIDE PARTE EXTERIOR | INTERNO INTERNAL SIDE PARTE INTERIOR | ESTERNO EXTERNAL SIDE PARTE EXTERIOR | | | | UNI EN 16034 | EN 1634-1 | EN 13501-2 | Classificazione | Lmax | Hmax | Area max |
| | | | | | | | | | | | | | | | | | |
| MAGMA EI2-30 | NO | NO | 42 | L | L | SI | SI | 2 | NPD | 42 dB | EI2-30 | 1035 | 2415 | 2,26 | | | |
| MAGMA EI2-60 | NO | NO | 40 | L | L | SI | SI | 2 | NPD | 40 dB | EI2-60 | 1035 | 2357 | 2,20 | | | |
| MAGMA EI2-90 | NO | NO | 42 | L | L | SI | SI | 2 | NPD | 42 dB | EI2-90 | 1035 | 2300 | 2,16 | | | |
| WALL EI2-60 | NO | NO | Para aria acustico | L | L | SI | SI | 1,6 | 3 | 39 dB | EI2-60 | 1150 | 2357 | 2,46 | | | |

*PER PANNELLI PANTOGRAFATI O IN ALLUMINIO CON COIBENTAZIONE SOTTO AL PANNELLO:

PRESENZA DI BATTUTA PERIMETRALE 6X16 - A SPORGERE.

*For pantographed or aluminium coatings with insulation under the panel: presence of 6x16 lateral working - the panel leans out

*Pour panneaux pantographés ou en aluminium avec isolation sous le panneau: seuil de périmètre 6x16 en saillie

** VALORI ARIA-ACQUA-VENTO PER STEEL / SILVER / STEELPLUS / GOLD SENZA SOPRALUCE E CON SOGLIA SVIZZERA: 2 - 4B - A5

** Air-water-wind performances for Steel / Silver / Steelplus / Gold models without glass transom and with Swiss sill: 2 - 4B - A5

** Valeurs AAV pour Steel / Silver / Steelplus / Gold sans puits de lumière et avec seuil 15mm : 2 - 4B - A5

NOTA - NELLA TABELLA SONO STATE INSERITE SOLO ALCUNE DELLE COMBINAZIONI POSSIBILI. LE PRESTAZIONI INDICATE POTRANNO, NEL CORSO DELL'ANNO, SUBIRE VARIAZIONI SIGNIFICATIVE A CAUSA DELLE MODIFICHE DI PRODOTTO O PER PARTICOLARI CONFIGURAZIONI.

The table does not include all possible combinations. The performances indicated could be improved during the year due to product modifications or particular configurations.

Note: Ce tableau ne reporte pas toutes les combinaisons possibles. Au cours de l'année, les performances indiquées pourront subir des variations significatives à cause de modifications du produit ou de configurations particulières.

TUTTI I PANNELLI DI RIVESTIMENTO PER PORTE BLINDATE ALIAS DEVONO ESSERE SCELTI CONSIDERANDO GLI AGENTI ATMOSFERICI A CUI SARANNO ESPOSTI.

Simboli che identificano il tipo di installazione consigliata:

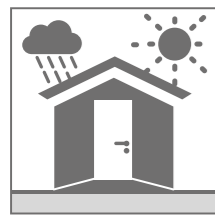

L'INSTALLAZIONE È CONSENTITA SOLO ALL'OMBRA, IN ATRII E PIANEROTTOLI.

Installation allowed in shade, atriums and half spaces.

L'installation n'est consentie qu'à l'ombre, dans les couloirs et sur les paliers.



SI CONSIGLIA L'INSTALLAZIONE DEL RIVESTIMENTO IN POSIZIONE RIPARATA SOTTO TETTOIE, PORTICATI E COPERTURE DI ALMENO CM 100.

Paneling installation is suggested in sheltered position under roofs, porches and ceiling of at least cm. 100.

Il est conseillé de monter le revêtement dans des lieux abrités, sous auvents, porches et sous-abris d'au moins cm. 100

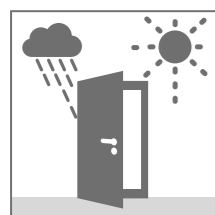

L'INSTALLAZIONE È CONSENTITA ANCHE ALLA PRESENZA DI SOLE, PIOGGIA E GELO.

Installation is allowed also in the sun, under rain and frost.

L'installation est consentie au soleil, sous la pluie et au gel.

LEGENDA

Legend / Légende

L Presenza di un pannello sp.6mm (valori validi anche per pannelli lisci CCE)
Panel 6mm thick (performances are valid also for CCE 6mm thick panels)
Tablero liso 6 mm (valores validos tambien para tableros CCE)

P Presenza di un pannello > 6mm (generalmente sp.15mm)
Panel > 6 mm thick (generally 15mm thick)
Tablero > 6mm (en general 15 mm espesor)

ALU Presenza di un pannello in alluminio
Aluminium panel
Panneau en aluminium

ABS Presenza di un pannello in ABS
ABS panel
Panneau en ABS

NPD Nessuna Prestazione Determinata
No Performance Determined
Pas de performance déterminée

I COLORI E LE ESSENZE DEI PANNELLI RIPRODOTTI SU QUESTO CATALOGO SONO INDICATIVI E IN NESSUN MODO VINCOLANTI PER ALIAS.

The colors and the essence of the panels that have been reproduced in this catalogue are indicative and they are in no way an obligation for Alias.

Les couleurs et les essences des panneaux reproduites dans ce catalogue sont indicatives mais non contraignantes en ce qui concerne Alias.

KIT DI TRATTAMENTO E PROTEZIONE

Maintenance and protection Kit

Kit de traitement et de protection

CON UNA SEMPLICE OPERAZIONE DI MANUTENZIONE, DA EFFETTUARSI OGNI SEI MESI, È POSSIBILE COMBATTERE IL NATURALE INVECCHIAMENTO DEL LEGNO. IL KIT COMPRENDE DUE PRODOTTI, UNO DETERGENTE E L'ALTRO PROTETTIVO DA APPLICARE SU TUTTI I NOSTRI RIVESTIMENTI.

It is possible to prevent the natural wood ageing with a simple maintenance operation to be done every 6 months. The kit includes 2 products: a detergent and protective product that can be used for all our panels.

Une simple opération d'entretien, à effectuer tous les six mois, permet de combattre le vieillissement naturel du bois. Le kit comprend deux produits, un détergent et un produit de protection à appliquer sur tous nos revêtements.



CONDIZIONI GENERALI DI VENDITA

• **OGGETTO DEL CONTRATTO:** Offerte, commissioni, conferme: il presente contratto viene di comune accordo considerato vendita in ogni sua parte e, come tale, assoggettato alla relativa disciplina legale anche quando comprende la posa in opera di prodotti acquistati e relativi servizi. Le offerte degli agenti e operatori di ALIAS, anche se fatte per iscritto sono soltanto dimostrative e non sono mai per essa impegnative; lo diventano solo quando, fatte proprie dal cliente per iscritto mediante sottoscrizione della conferma d'ordine (foglio commissione), la sede ALIAS abbia successivamente spedito al cliente il suo consenso scritto (conferma d'ordine) alla stipulazione del relativo contratto. Il cliente sottoscrivendo la conferma d'ordine pone in essere l'effettiva proposta che si obbliga a non revocare per almeno 7 giorni lavorativi. La sede ALIAS è libera di accettare o meno l'eventuale proposta di revoca. Qualora, eccezionalmente, la sede ALIAS consentisse la revoca della commissione entro la suddetta scadenza, essa avrà diritto ad una penale per spese tecnico-commerciali, comunque fatte o in corso, nella misura del 15% sulla somma risultante in commissione. Qualora il cliente, successivamente alla sottoscrizione della conferma d'ordine contenente la specifica dei prodotti ordinati, richiedesse la modifica di tali prodotti, dovrà comunicarlo entro 7 giorni lavorativi in forma scritta alla Venditrice che si riserva il diritto di comunicare, a sua volta, nuovi, eventuali, termini di consegna ed eventuali maggiori oneri che la modifica e, conseguentemente, la stessa consegna possa comportare. Eventuali ordini successivi a completamento saranno comunque soggetti alle condizioni dell'ordine principale o del listino prezzi in vigore ed i prezzi saranno di volta in volta riveduti anche in considerazione della frammentarietà degli ordini e del tempo trascorso dalla sottoscrizione del foglio commissione relativo all'ordine principale.

• **PREZZI:** se si verificano aumenti a) e dei costi di mano d'opera e/o b) del costo dei materiali e/o c) del costo dei servizi oggetto della fornitura la Venditrice avrà diritto di aggiornare corrispondentemente i prezzi secondo gli aumenti intervenuti fra la data della commissione d'ordine e la data in cui vengono ultimate le consegne dei materiali o le operazioni di posa in opera, anche se avvenute in ritardo. Gli aggiornamenti dei prezzi verranno applicati indipendentemente dagli accenti ricevuti e verranno addebitati con fattura pagabile come da condizioni di contratto.

• **PAGAMENTI:** è obbligo inderogabile dell'Acquirente effettuarli direttamente alla sede ALIAS e ciò vale anche se nelle condizioni particolari sono stati pattuiti o di fatto adottati il sistema di pagamento a mezzo tratte accettate, a mezzo cambiali, assegni, ricevute bancarie o simili. In caso di pagamento con effetti cambiari e/o assegni i titoli di credito dovranno essere intestati alla Venditrice ed essere completi di ogni requisito di legge; in difetto, l'Acquirente autorizza la venditrice a riempire il titolo incompleto successivamente con i dati mancanti conformemente alle condizioni particolari e generali del contratto di compravendita. Il rilascio di effetti cambiari si considera sempre "pro solvendo" e gli eventuali rinnovi non costituiscono mai novazione delle originali obbligazioni contrattuali. Nessuno al di fuori della sede ALIAS è autorizzato a ricevere pagamenti salvo il caso in cui sia munito di speciale procura ad hoc. Gli interessati sulle somme dovute a titoli di prezzo oppure di anticipazioni di imposte a carico del cliente, sia sugli acconti che sui pagamenti frazionati o rateali, che sui saldi, sono determinati in base al tasso pattuito nella misura indicata nelle condizioni particolari di pagamento. In mancanza di tale indicazione gli interessi si intendono pattuiti in misura pari al tasso ufficiale di sconto della Banca d'Italia all'atto della commissione maggiorato del 50%. Ogni pagamento ritardato sarà imputato prima in conto interessi scaduti poi a capitale. L'inadempienza anche parziale ai puntuali pagamenti così come l'insolvenza dell'Acquirente evidenziata da cessioni di beni, da protesti di assegni o cambiali o da aperture di procedure concorsuali nei suoi confronti da diritto ad ALIAS di sospendere la fornitura, anche se già in corso, e, anche, di risolvere immediatamente il contratto, chiedendo modalità e tempi più restrittivi di pagamento anche dopo il versamento di acconti o rilascio di effetti con totale esonero di risarcimento danni per la Venditrice. Nessuna eccezione o contestazione dell'Acquirente gli dà diritto di sospendere in tutto o in parte i pagamenti.

• **DECADENZA BENEFICIO DEL TERMINE:** In caso di pagamenti rateali il mancato pagamento anche di una sola rata provoca l'immediata scadenza delle successive con decadenza dell'Acquirente del beneficio del termine, anche se per ordini diversi e/o consegne ripartite.

• **CONSEGNA:** i termini che sono esclusivamente quelli indicati nella conferma dell'ordine non sono mai impegnativi per ALIAS, ma sono sempre soltanto approssimativi; essi decorrono in ogni caso non dalla data della commissione, ma dalla data della conferma d'ordine da parte di ALIAS e, se successiva, dalla data di ultimo arrivo alla sede ALIAS dei dati, progetti, elaborati, specifiche o elementi utili e comunque definitivi per l'esecuzione del contratto. Ogni termine per ALIAS è convenuto anche con la clausola del salvo imprevisi di lavorazione, scioperi, avversità atmosferiche, cause fortuite o di forza maggiore. L'adempimento dei termini di consegna dei prodotti da parte di ALIAS si conviene che è assolto allorché essa li abbia pronti in stabilimento per l'epoca convenuta, qualunque sia il posto pattuito per la consegna. Per luogo di consegna si stabilisce inderogabilmente lo stabilimento di produzione: ogni pattuizione di consegna in ogni altro luogo e relative forme e operazioni e gli ulteriori servizi e prestazioni, si intendono essere obbligazioni accessorie al contratto fondamentale di compravendita. Trascorsi i termini di consegna senza il ritiro della merce da parte dell'Acquirente, ALIAS ha il diritto di procedere ai sensi dell'articolo seguente. Per i materiali così a disposizione dell'Acquirente ogni eventuale posticipazione di data di consegna deve essere da lui richiesta alla sede ALIAS per iscritto almeno 30 giorni prima della data prefissata; in ogni caso ALIAS ha il diritto di stabilire nuovi termini di consegna oppure di rifiutare il differimento del termine con la risoluzione automatica delle successive eventuali obbligazioni di contratto.

• **RITARDO NEL RITIRO DEI PRODOTTI:** trascorsi 15 giorni dalla data prevista per la consegna senza che l'Acquirente abbia ottemperato ai suoi obblighi entro i termini pattuiti, anche se non ritira, i prodotti stessi si intendono, con la scadenza di tale data, consegnati a tutti gli effetti, anche contrattuali e del pagamento, nonché della responsabilità e del rischio e così anche del deterioramento che è danno dell'Acquirente il quale, dalla data stessa, è obbligato a pagare, inoltre, ad ALIAS un indennizzo per spese di immagazzinaggio pari ad Euro 10/pezzo/mese.

• **POSA IN OPERA:** quando previsto nel contratto a carico di ALIAS deve intendersi prestazione accessoria al contratto di vendita dei prodotti e, in quanto tale, la committente riconosce che non costituisce appalto. Deve essere richiesta non oltre due mesi dalla data di consegna della merce e si svolge compatibilmente alla disponibilità della mano d'opera da parte della Venditrice al momento della richiesta senza responsabilità per essa per eventuali ritardi. Se la posa in opera dovesse essere interrotta dall'Acquirente per qualsiasi ragione sarà poi ripresa con tempi e costi da concordare e qualora l'Acquirente pur avendo richiesto la posa in opera per motivi di cui sopra o per accelerare il lavoro, dovesse ricorrere ad altro personale, previo accordo scritto con la Venditrice, alla stessa non verranno esposti gli oneri di posa in opera come previsti nel contratto e null'altro. La posa in opera e le opere murarie ad essa legate sono essenziali per il buon funzionamento del prodotto e per l'ottenimento delle prestazioni dichiarate. ALIAS farà decadere tutte le garanzie legali sul prodotto in caso di posa eseguita dall'Acquirente direttamente o in subappalto in modo difforme da quanto indicato dalle istruzioni di prodotto o in generale dalla buona norma tecnica di prodotto. Ultimata la posa in opera eseguita da mano d'opera della Venditrice, l'Acquirente deve rilasciare il benessere alla squadra di posa onde facilitare alla Venditrice il controllo del lavoro eseguito. In caso di mancato rilascio del benessere di posa in opera la fornitura si intende accettata senza riserve dall'Acquirente. In ogni caso l'abilitazione dell'immobile o la consegna dello stesso a terzi viene espressamente considerata dalla Venditrice e dall'Acquirente incondizionata accettazione della fornitura con l'esenzione per la Venditrice di qualsiasi ulteriore onere.

• **GARANZIA:** il committente accorda alla Venditrice tutte le tolleranze d'uso sulle dimensioni e sulle tipologie accessorie. Nel caso la merce non potesse essere utilizzata per difetti di materiale o altro imputabile alla Venditrice, e che questa riconosca, essa ha la facoltà o di sostituirla o di effettuare le possibili riparazioni oppure di rimborsarne il relativo prezzo con esclusione per l'Acquirente di pretendere indennizzi di qualsiasi genere neppure per il ritardo per mano d'opera, per trasporto o altro. Non sono validi quei reclami effettuati con modalità diverse da quelle specificate nell'articolo seguente. L'eventuale accredito ha corso solo dopo che alla Venditrice è stata restituita la merce contestata, così pure per la sostituzione. L'Acquirente dichiara a tutti gli effetti di aver visionato il campione di prodotti ordinati, dandone specifica approvazione.

• **RECLAMI E DIRITTO DI RECESSO:** per qualsiasi genere e causa per essere validi devono essere fatti a mezzo lettera raccomandata direttamente ad ALIAS s.r.l. con sede legale e operativa in Via Berlinguer, 22 - Settima di Gossolengo (PC) entro il termine perentorio di 10 giorni lavorativi dall'arrivo della merce ordinata.

• **SPEDIZIONE E TRASPORTI:** come accessorio al contratto di compravendita potrà essere pattuita tra ALIAS e l'Acquirente la spedizione a mezzo ferrovia o corriere oppure automezzo dell'ALIAS o da questa in qualunque modo fornito. In questo caso resta inteso che la compravendita è indipendente dalla pattuizione di cui sopra ed è già esaurita al momento della merce pronta in stabilimento. Resta inteso che le obbligazioni della ALIAS relative alla conservazione e tempi di consegna per il trasporto della merce, si esauriscono al momento del carico sui messi forniti dall'Acquirente, o in nome e per conto dell'Acquirente, per il prelievo e il trasporto, ovvero alla consegna alla ferrovia o al corriere per l'esecuzione del trasporto. Se la consegna è a mezzo autotreno non inviato dall'Acquirente, il trasporto viene effettuato sin dove la strada è facilmente accessibile al mezzo impiegato. Nessuna responsabilità per fatti o ritardi inerenti a spedizioni a mezzo ferrovia, corrieri, automezzi inviati dall'Acquirente o agenti a suo nome e conto, potrà essere addebitato ad ALIAS. Per i trasporti a mezzo veicoli ALIAS o da essa in qualunque modo forniti si intende che fine l'accettazione della presente clausola sta per delega ad ALIAS da parte dell'Acquirente al compimento delle predette operazioni. I materiali di imballo in legno, gomma ed altro, devono essere restituiti alla ALIAS franco stabilimento di provenienza, o, in difetto, saranno fatturati all'Acquirente. In mancanza di precisi accordi per imballaggi particolari la Venditrice provvederà come da propria prassi e così l'imballaggio si intenderà eseguito a regola d'arte qualora accettato senza riserve da parte del vettore. La merce viaggia sempre per conto, rischio e pericolo del committente anche se convenuta resa franco destino.

• **RISERVA DI PROPRIETÀ:** la proprietà della merce è riservata alla Venditrice con espresso divieto all'Acquirente di alienarla prima del completo pagamento. La merce potrà essere rivendicata dalla Venditrice ovunque essa si trovi. Il mancato pagamento anche di una sola rata determina la risoluzione di diritto del contratto. I versamenti effettuati vanno integralmente a beneficio della Venditrice a titolo di indennità, salvo maggiori danni e ciò in deroga all'art.1525 c.c.. Agli effetti di quanto sopra per ogni responsabilità conseguente, la Venditrice è autorizzata a portare a conoscenza dell'eventuale proprietario dell'immobile o terzo o comunque interessato il contratto ed il patto di riservato dominio.

• **COMPETENZA GIUDIZIARIA:** per qualsiasi controversia derivate dal presente contratto, nonché dalla sua interpretazione ed esecuzione, sarà esclusivamente competente l'autorità giudiziaria di Piacenza; ciò anche se il pagamento sia convenuto a mezzo cambiali domiciliare presso il debitore. Tale competenza non può essere derogata neppure per ragioni di connessione, comunione o garanzia.

• **INFORMATIVA AI SENSI DELL'ART. 13 del D.Lgs. 30.06.2003 n. 196.** Ai sensi dell'art. 13 del D.Lgs. 196/2003, ALIAS s.r.l. con sede legale e operativa in Via Berlinguer, 22 Settima di Gossolengo PC, Titolare del trattamento dei dati, La informa che: i dati raccolti da ALIAS srl saranno trattati elettronicamente per l'evasione degli Ordini e per finalità connesse, nonché ai fini di elaborazione statistica e per iniziative promozionali e di marketing. La natura del conferimento dei dati è facoltativa. I dati sono comunque necessari per l'adempimento dell'incarico richiesto dall'interessato, e senza di essi sarà impossibile svolgere alcuna attività a favore del richiedente. L'accesso ai dati è consentito ai soggetti specificatamente incaricati quali dipendenti, consulenti, terzi fornitori di servizi per le finalità su indicate ovvero potranno essere comunicati all'esterno nell'ambito di società controllanti e controllate. Inoltre come previsto dagli articoli 7, 8, 9, 10 del D.Lgs. n. 196/2003, ogni interessato può richiedere in qualsiasi momento la conferma dell'esistenza, la modifica o la cancellazione dei propri dati, scrivendo al Responsabile Ufficio Clienti presso ALIAS.

GENERAL SALES CONDITIONS

• **CONTRACT OBJECT - OFFERS, COMMISSIONS, ORDER CONFIRMATION:** As agreed by the parties, the following contract is considered a sales contract in all its parts and for this reason it is subjected to the related legal rules even when it includes the set up and the related services. The offers of the sales agents and ALIAS personals, even in a written form, are only made for demonstrative scopes. They become obligations when the customers accept them signing the order confirmation (commission sheet) and after that ALIAS premises has sent to the customer its written approval (order confirmation) of the drawing up of the agreement. The customer, signing the order confirmation, puts in place the real proposal and he is engaged not to withdraw it for at least 7 working days. ALIAS's premises is free to accept or not the eventual withdraw proposal. If ALIAS premises would consent in an exceptional manner to the withdraw of the proposal within the above deadline, ALIAS will have to right to ask for a penalty for the incurred or current technical-commercial expenses of the value of 15% of the amount that comes from the commission. If the customer, after the order confirmation's signature that contains the ordered products features, would ask for a modification, he should communicate it within 7 workings days in written form to ALIAS's premises which reserves the right to communicate eventual news delivery times and eventual prices increase. Eventual further completion orders will be subjected to the same conditions of the main order and or to the current price list and the prices could be revised due to the orders fragmentary and spent time from the main order.

• **PRICES:** If increases of workforces' costs and/or material costs and/or costs of the services included in the orders occur, ALIAS has the right to update the prices according to the increases occurred between the commission's date and the delivery of material or the setup' date, even if with delay. The price revisions will be applied independently from the advance payments and it will be charged with invoice as per contract conditions.

• **PAYMENTS:** The Buyers has to carry out all the payments directly to ALIAS's premises and even if particular conditions have been agreed such as drafts, bill of exchanges, checks or cash orders and similar. If these kind of payments have been agreed, the drafts should be issued on behalf of ALIAS and it should be filled in according to law dispositions, in case of incomplete draft, the buyer authorizes the seller to fill in the draft with all the missing data according to the particular conditions of the sales contract. The issue of bills of exchange is always considered "pro solvendo" and eventual renewals are never a novation of the original contract obligations. No one outside ALIAS's premises is authorized to receive payments except a special attorney. The interests of the sums that comes from drafts, or from clients advanced payments taxes, or partial payment or installment payment or balance, are fixed according to the agreed rate indicated in the sales contract. If there is not a specific indication, the interests are fixed according to the official discount rate established by Banca di Italia at the time of commission, increased of 50%. Each delayed payments will be charged first to interests account then to capital. The default, even partial, of the payments along with the insolvency of the buyer demonstrated by real estate transfers, protest of a bill or bankruptcy proceedings, allows ALIAS to suspend the supply, even if it is already in due course and also to withdraw the contract immediately, asking for more restrictive terms of payments even after advanced payments or drafts issues with entire exemption from damages payments for the Sellers. No exceptions or contestations of the buyers allow to suspend partially or entirely the payments.

• **EXTINCTION TERM'S BENEFIT:** In case of installment payments, the nonpayment of even a single rate causes the immediate expiry of the other rates with the extinction for the buyer of the terms benefit, even for different orders and/or split delivery.

• **DELIVERY:** The terms are exclusively indicated in the order confirmation and they are never binding for ALIAS, but they are approximate. They become effective not from the commission date, but from the signature of the order confirmation issued by ALIAS and, if following, from the date of the last arrival to ALIAS premises of information, projects, requirements and all the useful and definitive elements to carry out the contract. Each terms for ALIAS is agreed with the clause of unless unforeseen of workings, strikes, weather adversity, accidental causes, or force majeure. The fulfillment of the delivery terms of the products is effective for ALIAS when the product are ready to load at the agreed date, whatever it is the delivery address. As delivery address it is established without exception the manufacturing plant: every different agreement about the delivery and the related forms and necessary operations and services are accessory obligations to the main sales contract. Expired the delivery terms without the goods collecting by the buyer, ALIAS has the right to proceed as per the following article. So, for the available goods for the buyer, every slipping of the delivery date should be communicated by written form to ALIAS premises at least 30 days before the agreed date. Nevertheless, ALIAS has the right to fix new delivery terms or to refuse the slipping of the delivery date with the automatic withdrawing of latter contract obligations.

• **DELAY IN THE GOODS COLLECTING:** After 15 days from the fixed delivery date, if the buyer hasn't fulfilled to his obligations within the agreed deadlines, even if he doesn't collect the goods, the products are to be considered as effectively delivered also from contractual, payment, risk, responsibility and deterioration of the goods point of view. Moreover, the buyer should pay to ALIAS an indemnity for stock expenses of 10€/piece/month.

• **SETUP:** If the set up requested to ALIAS is included in the contract, it is an accessory service to the sales contract and therefore the buyer acknowledges that it is not a tender. It should be requested within 2 months from the delivery date and it will be carried out according to the workforce's availability at the moment of the request without the responsibility for any delay. If the setup is suspended by the buyer for any reasons, it will be restarted with revised prices and terms. If the buyer, despite it has requested the setup, for reasons as above or to speed-up the job, would use other personnel, prior written consent of the seller, no setup costs will be charged, as agreed in the contract. The set up and the related works walls are essential for a proper functionality of the product and to ensure the declared performances. ALIAS will let decay all the legal warranties of the product if the set up carried out by the buyer doesn't comply with the product instructions or

generally speaking with good technical standards. Once the setup is finished by the Seller personnel, the buyer should release his approval to let Seller check the done job. If no approval is released, the supply is considered as fully accepted by the buyer. However, the habitability of the property or its delivery to a third party is considered expressly by the seller and by the buyer as unconditional approval of supply with the exemption for the seller of any further obligations.

• **WARRANTY:** The buyer accords to the seller all the use allowances of dimensions and accessories. If the goods could not be used for material defects or for any other reasons to be ascribed to the sellers acknowledged by the seller, the seller has right to replace the goods or to carry out the possible fixings or to reimburse its price with the exception for the buyer to claim anything else nor for the workforce or transports. The claims that don't comply the procedures illustrates in the above article are not valid. The eventual credit can be executed only after that the rejected goods have been given back to the sellers and also for the replacement. The Buyer declares to have inspected the sample of the ordered products, approving it expressively.

• **CLAIMS AND RIGHT TO WITHDRAW:** For any reasons, the claims should be done by record letter address to ALIAS s.r.l. with legal premises in Via Berlinguer 22 - Settima di Gossolengo (PC) within the deadline of 10 workings days from the arrival of goods.

• **DELIVERY AND TRANSPORTS:** As accessory the sales contract, the transport of good could be agreed between ALIAS and the buyer. The transport could be carried out by train, courier or by ALIAS vehicle. In this case, the sale is independent from the agreement about the transport and it is run out as long as the goods are ready ex works. It is understood that the obligations for ALIAS that concern the storage and the delivery times of the goods transport are fulfilled when the goods are loaded up to means supplied by the buyer or on behalf of the buyer or when the goods are delivered to train or to the courier for the transport execution. If the delivery is carried out by a vehicle not sent by the buyer, the transport will be done till the road will be accessible. No responsibility for delays or any other issues related to transport by train, couriers, vehicles or agents sent by the buyer or on behalf of the buyer could be charged to ALIAS. For transports carried out by ALIAS means or generally supplied by ALIAS, it is understood that the approval of this clause is a proxy to ALIAS from the buyer to carry out these operations. The wood or rubber packages should be given back to ALIAS ex works or if not given back the packages will be invoiced. If there aren't detailed agreements about packages, the Seller will go ahead with the usual packages therefore it will be understood that they are made workmanlike if the buyer accepts them without reserves the package. The goods travel always at buyer risk's even if the goods are FOB.

• **PROPERTY RESERVE:** The goods property is reserved to the Seller with the express prohibition for the Buyer to give them away before the complete payment. The goods could be claimed by the Seller no matter where they are. The missed payment of even only a rate causes the contract withdraw. The payments on behalf of the Seller are to be considered as indemnity, unless greater damages in derogation to art. 1525 c.c. All this provided and for all the concerned responsibilities, the seller is authorized to let the final owner of the property or the third parties know the conditional right of domain.

• **LEGAL JURISDICTION:** For all the disputes arisen from this contract and its interpretation and execution, the only authority that has jurisdiction is Piacenza court, even though the agreed payments are drafts located at premises loaner. This jurisdiction can't be derogated not even for reasons of concession, guaranties or communions.

• **INFORMATIVE ACCORDING TO ART 13. D.LGS 30.06.2003 N.196.**

According to art. 13 D.lgs. 196/2003, ALIAS s.r.l. with legal premises in Via Berlinguer 22 Settima di Gossolengo PC, Legal owner of data treatment, informs that: data collected by ALIAS will be treated in an electronic way for orders execution and connected scopes, for statistics elaboration and for promotional and marketing scopes. The essence of the given information is facultative. The data are however necessary for the execution of the requested tasks and without them it is impossible to carry out any requested activity. Data access is allowed to clearly indicated subjects such as dependents, consultants, services of suppliers for the indicated scopes or they could be communicated to related companies. Moreover, as per art. 7,8,9,10 D.Lgs n. 196/2003, everyone who may be concerned can ask for, in every moment, the confirm of the existence, the modification or the cancellation of his own data, writing to Chief Customer Office in ALIAS.

CONDITIONS GENERALES DE VENTE

• **OBJET DU CONTRAT:** offres, commissions, confirmations. Ce contrat est de commun accord stipulé pour la vente, dans chacune de ses parties et, comme tel sujet à la discipline légale, même là où la pose des produits achetés et de ses services sont impliqués.

Les offres des agents et des intervenants ALIAS, même si rédigées ne sont qu'indicatives; elles ne deviennent obligatoires qu'au moment où, une souscription de confirmation de commande (feuille de commission) est signée par le client, ALIAS expédiera alors au client son accord écrit (confirmation de commande) en conclusion du Contrat en question. Le client qui souscrit la confirmation de commande accepte la proposition qu'il s'engage à ne pas la révoquer pendant au moins 7 jours ouvrables. ALIAS est libre d'accepter ou de refuser une éventuelle proposition de révocation. Si ALIAS consent, exceptionnellement, à la révocation de la commission avant l'échéance mentionnée ci-dessus, elle aura droit à une pénale pour les frais technico-commerciaux déjà soutenus ou en cours, dans la mesure de 15% sur la somme résultant de la commission. Si par la suite, après la confirmation de la commande contenant la définition des produits ordinaires, le client en demande la modification, il devra le communiquer dans les 7 jours ouvrables, par écrit, au Vendeur qui se réserve le droit de lui communiquer éventuellement, à son tour, les nouvelles conditions de livraison et les éventuelles augmentations de frais que la modification et, par conséquent, la livraison peuvent comporter. Les commandes complémentaires sont sujettes aux conditions de la commande principale ou de la liste de prix en vigueur, les prix sont, chaque fois, révisés selon la fragmentation des commandes et du délai après la souscription de la feuille de commission concernant la commande principale.

• **PRIX:** si des augmentations se vérifient sur a) les coûts de main d'œuvre et/ou b) le coût des matériaux et/ou c) le coût des services objet de la fourniture, le Vendeur se réserve le droit d'actualiser les prix, selon les augmentations entre la date de commission de commande et la date à laquelle les livraisons de matériaux ou la pose se sont terminées, même si avec un quelconque retard. Les modifications de prix seront appliquées indépendamment des acomptes déjà perçus, elles seront facturées et dues selon les conditions du contrat.

• **PAIEMENTS:** L'Acquéreur doit obligatoirement effectuer les paiements directement à ALIAS; ceci reste valable même si, dans des conditions particulières, un mode de paiement : par traites, billets à ordre, chèques, enregistrements bancaires ou autres, a été stipulé ou de fait adopté. Si un mode de paiement par lettres de change et/ou chèques est accepté, ces titres de crédit devront être libellés à l'ordre du Vendeur et remplis selon les dispositions légales; par défaut, l'Acquéreur autorise le Vendeur à compléter le titre incomplet avec les données manquantes conformément aux conditions particulières et générales du contrat de vente. La délivrance des billets à ordre est toujours considérée "pro solvendo" sans recours et les éventuels renouvellements ne constitueront jamais la novation des obligations contractuelles originales. Personne, à l'exception d'ALIAS, n'est autorisé à recevoir des paiements sauf si muni d'une procuration exceptionnelle ad hoc. Les intérêts des sommes dues à titre de prix ou d'anticipations d'impôt à charge du client, aussi bien sur les acomptes que sur les paiements fractionnés ou échelonnés, ou sur les soldes, sont déterminés d'un commun accord, selon un taux indiqué dans les conditions particulières de paiement. Sans indications précises, les intérêts s'entendent stipulés à hauteur du taux officiel d'escompte de la Banca d'Italia au moment de l'acte de commission majoré de 50%. Tout paiement retardé sera affecté d'abord sur le compte intérêts échus puis au capital. Le non-respect même partiel des paiements ainsi que de l'insolvabilité de l'Acquéreur mise en évidence par cession de biens, protestation de chèque ou de billets à ordre ou ouverture de procédure collective à son égard, autorise ALIAS à la suspension de la fourniture, même si déjà en cours, à la résolution immédiate du contrat, à une demande plus restrictive des modalités et à des délais de paiement même après versement des acomptes ou délivrance de titres, exonérant totalement le Vendeur de réparations et de dommages-intérêts. Aucune exception ni contestation de la part de l'Acquéreur ne lui donne le droit de suspendre les paiements en tout ou en partie.

• **ANNULLATION DU BENEFICE DE DELAI:** Dans le cas de paiements échelonnés, le non-paiement, ne serait-ce que d'un seul versement, provoque l'immédiate échéance des tranches suivantes, avec déchéance pour l'Acquéreur du bénéfice de délai, même en cas de différentes commandes et/ou de livraisons fractionnées.

• **LIVRAISON:** les délais ALIAS sont exclusivement les délais indiqués dans la confirmation de commande, ils ne sont jamais définitifs, mais toujours et seulement approximatifs; ils ne prennent pas effet à la date de commission, mais à la date de confirmation de commande de la part d'ALIAS, les suivantes commandes à la date du dernier arrivage, chez ALIAS, des données, projets, élaborés, détails ou tous autres éléments utiles pour l'exécution du contrat. Pour ALIAS tous les délais sont convenus avec la clause sauf imprévus d'usinage, de grèves, d'adversités atmosphériques, de causes fortuites ou de force majeure. Le respect des délais de livraison des produits est respecté et acquitté par ALIAS si Alias a les produits dans ses établissements au moment convenu, quel que soit le lieu de livraison. Par lieu de livraison, on entend sans restriction, l'établissement de production: toute stipulation de livraison dans un lieu et dans ses formes autres, différentes opérations, ultérieurs services et prestations s'entendent comme des obligations accessoires au contrat de vente. Quand les délais de livraison sont passés sans retrait de marchandise de la part de l'Acquéreur, ALIAS a le droit de procéder comme suit. Pour les matériaux à disposition de l'Acquéreur, tout éventuel report de date de livraison doit être demandé par lui, à ALIAS, par écrit, 30 jours au moins avant la date fixée; dans tous les cas ALIAS a le droit d'établir de nouveaux délais de livraison ou de refuser le report du délai et automatiquement des autres obligations de contrat.

• **RETARD DANS LE RETRAIT DES PRODUITS:** si 15 jours s'écoulent après la date de livraison prévue et que l'Acquéreur n'a pas obtenu le produit à ses obligations dans les délais <établis, même s'il ne retire pas les produits ceux-ci sont considérés comme livrés à tous les effets, même contractuels, paiement, responsabilité, risque ainsi que la détérioration est au détriment de l'Acquéreur qui, de plus, après cette date, est obligé de verser, à ALIAS une indemnisation pour frais de stockage égale à Euro 10/piece/mois.

• **POSE:** quand la pose prévue dans le contrat est à la charge d'ALIAS, elle devient prestation accessoire

au contrat de vente des produits et, en tant que telle, l'Acquéreur sait qu'elle ne constitue pas un contrat, qu'elle doit être demandée avant deux mois au plus tard de la date de livraison de la marchandise et qu'elle sera effectuée selon la disponibilité de la main d'œuvre du Vendeur au moment de la demande sans responsabilités en cas de retard. Si la pose est interrompue par l'Acquéreur pour quelque raison que ce soit, et reprise par la suite, les délais et les coûts seront à définir et si l'Acquéreur - ayant demandé la pose pour les raisons mentionnées ci-dessus ou pour accélérer le travail- devait s'adresser à un autre personnel avant accord écrit avec le Vendeur, les frais de pose ou autres ne seront pas mentionnés dans le contrat comme prévu. La pose et les travaux de maçonnerie qui lui sont liés étant essentiels pour le bon fonctionnement du produit et pour l'obtention des performances déclarées, ALIAS annulera toutes les garanties légales sur le produit en cas de pose effectuée par l'Acquéreur directement ou en sous-traitance, différemment de ce qui est indiqué dans les instructions du produit ou en général selon les normes techniques du produit. Une fois la pose effectuée par la main d'œuvre du Vendeur, l'Acquéreur doit délivrer l'agrément à l'équipe de pose afin de faciliter le Vendeur dans ses contrôles de travaux réalisés. A défaut de délivrance d'agrément de pose, la fourniture s'entend acceptée sans réserve par l'Acquéreur. L'habilitation ou la livraison de l'immeuble à des tiers est expressément considérée comme acceptation inconditionnée de la fourniture par le Vendeur et par l'Acquéreur avec exonération pour le Vendeur de tout frais ultérieurs.

• **GARANTIE:** l'Acquéreur accorde au Vendeur toutes les tolérances d'emploi sur les dimensions et sur les typologies accessoires. Au cas où la marchandise ne pourrait pas être utilisée à cause de défauts du matériau ou autres, imputables au Vendeur qui le reconnaît, le Vendeur a la possibilité de la remplacer, d'effectuer les réparations possibles ou d'en rembourser le prix, l'Acquéreur ne pourra prétendre aucun dommage-intérêts de quelque nature que ce soit ni pour le retard, ni pour la main d'œuvre, ni pour le transport ou autres. Les réclamations effectuées différemment de celles qui sont désignées dans l'article suivant ne sont pas recevables. L'éventuel accrédité ne peut avoir lieu qu'une fois que la marchandise contestée a été restituée au Vendeur, il en est de même pour le remplacement. L'Acquéreur déclare à tous les effets avoir visionné l'échantillon des produits commandés, et en donne son approbation.

• **RECLAMATIONS ET DROIT DE RECESSION:** Pour être incontestables toutes réclamations et tous droits de récession doivent être adressés par lettre recommandée directement à ALIAS s.r.l. dont le siège légal et les bureaux sont Via Berlinguer, 22 - Settima di Gossolengo (PC), avant un délai impératif de 10 jours ouvrables de l'arrivée de la marchandise commandée.

• **EXPEDITION ET TRANSPORTS:** en tant qu'accessoire au contrat de vente, l'expédition et le transport par chemin de fer ou par courrier ou encore par camion ALIAS pourront être négociés entre ALIAS et l'Acquéreur. Dans ce cas, la vente est indépendante de l'accord de transport mentionné ci-dessus et expire au moment où la marchandise est prête dans l'établissement. Il reste bien entendu que les obligations d'ALIAS concernant la conservation et les délais de livraison pour le transport de la marchandise s'épuisent au moment du chargement sur les moyens de transport fournis par l'Acquéreur, au nom et pour le compte de l'Acquéreur, pour le prélèvement et le transport, c'est à dire à la livraison au chemin de fer ou au courrier pour l'exécution du transport. Si la livraison est effectuée par camion non envoyé par l'Acquéreur, le transport est effectué jusque-là où la route est facilement accessible aux moyens utilisés. Aucune responsabilité pour des faits ou des retards inhérents aux expéditions par chemin de fer, courriers, camions envoyés par l'Acquéreur ou agissant en son nom et pour son compte, ne pourra être débitée à ALIAS. Pour les transports par véhicules ALIAS ou fournis par Alias, il s'entend que l'acceptation de cette clause est un serveur mandataire à ALIAS de la part de l'Acquéreur à l'achèvement des opérations mentionnées ci-dessus. Les matériaux d'emballage en bois, en caoutchouc et autres doivent être rendus à ALIAS franco établissement de provenance, ou, à défaut, ils seront facturés à l'Acquéreur. Si aucun accord sur les emballages n'existe, le Vendeur continuera selon ses pratiques, l'emballage sera alors considéré comme effectué dans les règles une fois accepté sans réserves par le transporteur. La marchandise voyage toujours pour compte et aux risques et périls de l'Acquéreur même FOB.

• **RESERVE DE PROPRIETE:** la propriété de la marchandise est réservée au Vendeur, il est donc expressément interdit à l'Acquéreur de la céder avant le paiement total. La marchandise pourra être réclamée par le Vendeur où qu'elle soit. Un défaut de paiement ne serait-ce que d'un seul versement détermine la résolution du contrat. Les versements effectués sont alors intégralement au bénéfice du Vendeur à titre d'indemnité, sauf dommages plus importants, cela par dérogation à l'art.1525 C.C.. De ce qui précède en ce qui la responsabilité, le Vendeur est autorisé à communiquer le contrat et le pacte de location-vente à un éventuel propriétaire de l'immeuble ou à des tiers ou à toute partie intéressée.

• **COMPETENCE JUDICIAIRE:** pour tout litige venant de ce contrat, ainsi que de son interprétation et exécution, seule la juridiction de Plaisance est compétente; même lorsque le paiement est effectué par billet à ordre domicilié chez un débiteur. Une telle compétence ne peut être dérogée ni pour connexion, communion ou garantie.

• **DECLARATION AUX SENS DE L'ART. 13 DU D.L. 30.06.2003 n. 196.**

Aux sens de l'art. 13 du D.L. 196/2003, ALIAS s.r.l. dont le siège légal et les bureaux sont Via Berlinguer, 22 Settima di Gossolengo PC, Titulaire du traitement des données, informe que: les données recueillies par ALIAS

s.r.l. seront traitées électroniquement pour l'acheminement des commandes et pour les objectifs associés, ainsi que pour la production de statistiques pour des initiatives promotionnelles et de marketing. L'apport des données est facultatif. Toutefois, les données sont nécessaires pour l'exécution de la mission demandée par l'intéressé, sans lesquelles il est impossible d'exercer toute activité en faveur du demandeur.

L'accès aux données n'est consenti qu'aux personnes formellement nommées comme employés, consultants, fournisseurs de services sous-traitant, dans le but indiqué ci-dessus à savoir les données pourront être communiquées auprès de sociétés apparentées. De plus, comme prévu par les articles 7, 8, 9, 10 du D.L. n. 196/2003, toute personne intéressée peut demander à tout moment, la confirmation de l'existence, la modification ou l'annulation de ses propres données, en écrivant au Responsable du Bureau Clients ALIAS.



RTAPROGETTI Roberto Tortelotti Architetto

Roberto Tortelotti si laurea in architettura nel 1980 al Politecnico di Milano.

Nel 1981/82 frequenta il Master in Design della Domus Accademy di Milano seguendo in particolare l'insegnamento dell'arch. Michele De Lucchi.

Collabora con aziende brianzole operanti nell'arredo fra cui Glas, Porada, Tiemme per le quali progetta tavoli, sedie, letti e contenitori. Partecipa a mostre internazionali di design e a progetti organizzati dallo studio Alchimia dell'arch. Alessandro Mendini.

Successivamente progetta sedie per Calligaris, mobili contenitori per Lineaemme e partecipa ad un gruppo di progetti in collaborazione con l'Arch. Pepe Tanzi.

In parallelo segue il lavoro del suo studio che si occupa prevalentemente di interior design e di arte multimediale.

Dal 2002 prosegue la collaborazione con Dario Vaccari per la nuova azienda ALIAS SRL. Progetta uffici e show-room di cui segue la direzione lavori, il marchio e la grafica ALIAS nonché i primi modelli dei pannelli di rivestimento tuttora best-seller. In produzione: ONDA, MOUSE, seguiti da MOOD, CACTUS, NINE, MAP, OVAL e dagli altri modelli in ordine di tempo: LINEA, PLANAR, INOUT, con un interesse particolare rivolto alla multimedialità inserita nel modello PAIS ed ai decori personalizzabili introdotti su QUADRANTE. E ancora le più recenti collezioni: LISTEN, CARGO, METROPOLITAN, CARTOON, GIPSY, MARBLE.

Roberto Tortelotti graduated in Architecture at the Politecnico di Milano University in 1980.

In 1981/2 he attended the Domus Academy Master Course in Design in Milan, and in particular the lessons of the Italian architect Michele De Lucchi.

He worked for companies located in Brianza that operate in the home furnishing sector including Glas, Porada and Tiemme for whom he designed tables, chairs, beds and container-type furniture items.

He took part to international design exhibitions and in projects organized by the Italian architect Alessandro Mendini of Studio Alchimia. Then, he designed chairs for Calligaris, container-type furniture items for Lineaemme and took part in a number of projects in collaboration with the Italian architect Pepe Tanzi.

At the same time he worked in his own studio, focusing himself to design and multimedia projects.

Since 2002 he has been collaborating with Dario Vaccari and his new armoured doors company ALIAS.

He designed and supervised ALIAS offices and showroom realization, created the ALIAS trademark and its graphic identity, as well as the first door models that are still best sellers of the ALIAS product range: ONDA, MOUSE, that are followed by MOOD, CACTUS, NINE, MAP, OVAL. He also designed the more recent door lines: LINEA, PLANAR, INOUT, his great interest in multimedia has been implemented in PAIS door model and in customizable decorative items, as introduced in the QUADRANTE door model. LISTEN, CARGO, METROPOLITAN, CARTOON, GIPSY, MARBLE.

Roberto Tortelotti a obtenu son diplôme en architecture en 1980 à l'École polytechnique de Milan.

En 1981/82, il a suivi le Master en design de la Domus Academy de Milan, où il a notamment suivi l'enseignement de l'architecte Michele De Lucchi.

Il collabore avec des sociétés de la Brianza actives dans le secteur du mobilier, notamment Glas, Porada et Tiemme, pour lesquelles il conçoit des tables, des chaises, des lits et des conteneurs.

Participe aux expositions et projets internationaux de design organisés par le studio d'architecte Alchimia. Alessandro Mendini.

Plus tard, il conçut des chaises pour Calligaris, des meubles pour Lineaemme et participa à un groupe de projets en collaboration avec Arch. Pepe Tanzi.

En parallèle, suit les travaux de son atelier qui traitent principalement de design d'intérieur et d'art multimédia.

Depuis 2002, la collaboration avec Dario Vaccari pour la nouvelle société ALIAS SRL se poursuit.

Il conçoit des bureaux et des showrooms, suivi de la direction des travaux, de la marque et du graphisme ALIAS, ainsi que des premiers modèles des panneaux de revêtement les plus vendus. En production: ONDA, MOUSE, suivi de MOOD, CACTUS, NINE, MAP, OVAL et autres modèles par ordre chronologique: LINEA, PLANAR, INOUT, avec un intérêt particulier pour le multimédia inséré dans le modèle PAIS et les décorations personnalisables introduites sur DIAL. Et les dernières collections: LISTEN, CARGO, METROPOLITAN, CARTOON, GIPSY, MARBLE.

**“Mettersi insieme è un inizio,
rimanere insieme è un progresso,
lavorare insieme un successo.”**

**“Coming together is a beginning,
staying together is progress,
and working together is success.”**

**“Se mettre ensemble c'est un début,
rester ensemble est un progrès,
travailler ensemble est un succès.”**

Henry Ford

UN RINGRAZIAMENTO SPECIALE A TUTTI COLORO CHE HANNO CONTRIBUITO ALLA REALIZZAZIONE DI QUESTO CATALOGO - SEMPRE IN DIVENIRE: IDEAZIONE E COORDINAMENTO, FOTOGRAFIE, TESTI, TRADUZIONI, CORRETTORI DI BOZZE, STUDIO GRAFICO E IMPAGINAZIONE, STAMPA.

UN GRAZIE SPECIALE VA ANCHE A TUTTI COLORO CHE HANNO PRESTATO A QUESTE PAGINE LUOGHI PREZIOSI, INTIMI E PRIVATI, AFFIDATI ALLA CUSTODIA DEI MODELLI ALIAS.

INFINE, GRAZIE A TUTTI GLI ARCHITETTI E PROFESSIONISTI CHE HANNO SAPUTO TROVARE NELLE COLLEZIONI ALIAS OCCASIONI PER ESALTARE IL LORO PROGETTO E CHE HANNO AVUTO PIACERE A CONDIVIDERLO QUI.

Thanks to everyone involved in the production of this catalogue: design and coordination, pictures and texts, graphic and layout, printing.

Special thanks to those who lent their precious, intimate and private places to Alias to realize its project.

Last but not least, thank you to architects and professionals who found in Alias a chance to enhance their project and the pleasure to share it here

Un merci spécial à tous ceux qui ont contribué à la réalisation de ce catalogue - toujours en cours: idée et coordination, photographies, textes et traductions, relecteurs, étude graphiques et mise en page des textes, presse.

Un merci spécial va aussi à tous ceux qui ont prêté à ces pages des lieux précieux, intimes et privés, confiés à la garde des modèles ALIAS.

Enfin un merci à tous les architectes et professionnels qui ont su trouver dans les collections ALIAS, des occasions pour améliorer leur projet et qu'ont eu plaisir de le partager ici.



NOTA: Le riproduzioni dei colori sul catalogo cartaceo possono risentire di tutte le variazioni di tono e di colore imputabili ai processi di stampa. Queste immagini servono dunque esclusivamente per orientare la prima scelta del Cliente

All reproductions of colours on the paper catalogue can be subject to tone and shade variations that can be attributed to the print process. These images are inserted with the only purpose to guide customers in their first choice

La reproduction des couleurs du catalogue papier subit des variations de tons et de couleurs dues au processus d'imprimerie. Ces images servent donc exclusivement au client pour un premier choix

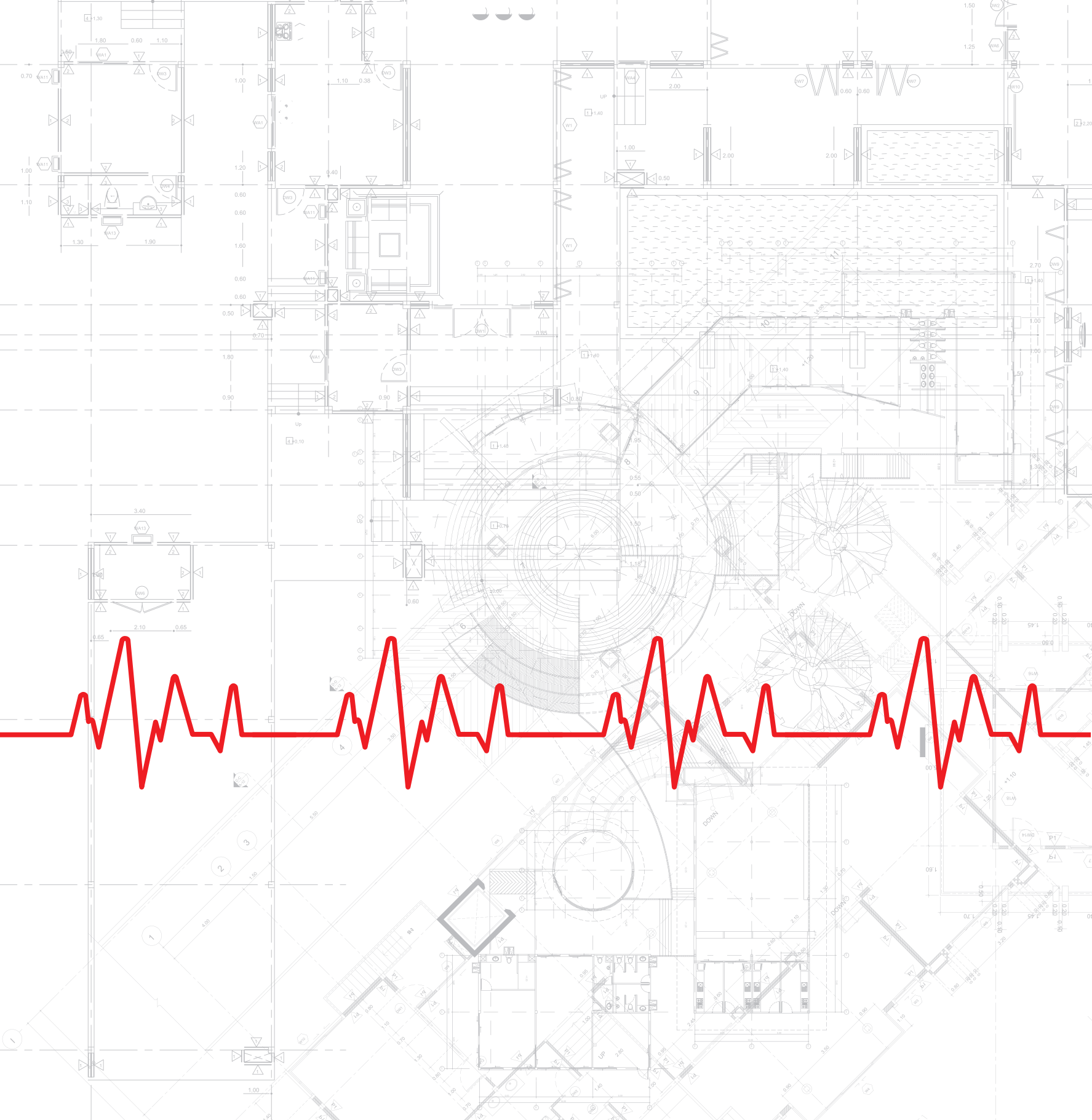

ALIAS

Alias srl

Via Berlinguer, 22 - Settima 29020 (PC) - Italy

T +39 0523 364040 **F** +39 0523 364044

E info@aliasblindate.com

w aliasblindate.com